

# Operating Instructions

## DVD Recorder

Model No. **DMR-EH65**



The illustration shows the model for Australia and N.Z.



For Australia and N.Z.

**G-CODE**®

# DIGA

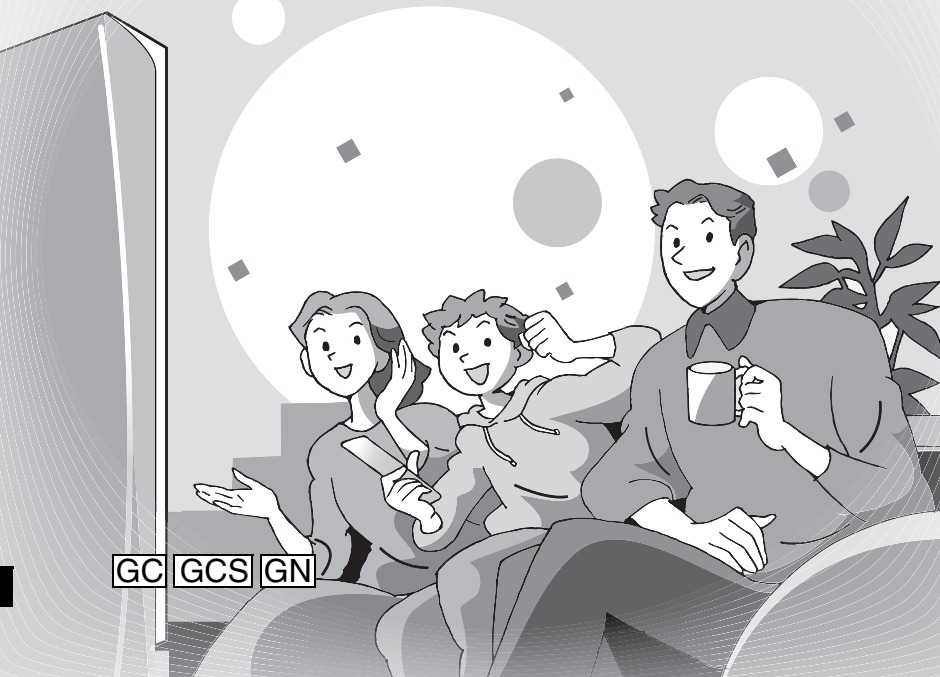

GC GCS GN

# Panasonic®

### Region number supported by this unit

Region numbers are allocated to DVD players and DVD-Video according to where they are sold.

#### For Asia

- The region number of this unit is "3".
- The unit will play DVD-Video marked with labels containing "3" or "ALL".

Example:



#### For Australia and N.Z.

- The region number of this unit is "4".
- The unit will play DVD-Video marked with labels containing "4" or "ALL".

Example:



#### For Middle East

- The region number of this unit is "2".
- The unit will play DVD-Video marked with labels containing "2" or "ALL".

Example:



### Dear customer

Thank you for purchasing this product. For optimum performance and safety, please read these instructions carefully.

Before connecting, operating or adjusting this product, please read the instructions completely. Please keep this manual for future reference.

Getting started

Recording

Playing back

Editing

Copying

Convenient functions

Reference

RQT8380-L

## CAUTION!

THIS PRODUCT UTILIZES A LASER.  
 USE OF CONTROLS OR ADJUSTMENTS OR  
 PERFORMANCE OF PROCEDURES OTHER THAN THOSE  
 SPECIFIED HEREIN MAY RESULT IN HAZARDOUS  
 RADIATION EXPOSURE.  
 DO NOT OPEN COVERS AND DO NOT REPAIR YOURSELF.  
 REFER SERVICING TO QUALIFIED PERSONNEL.

## WARNING:

TO REDUCE THE RISK OF FIRE, ELECTRIC SHOCK OR  
 PRODUCT DAMAGE, DO NOT EXPOSE THIS APPARATUS  
 TO RAIN, MOISTURE, DRIPPING OR SPLASHING AND THAT  
 NO OBJECTS FILLED WITH LIQUIDS, SUCH AS VASES,  
 SHALL BE PLACED ON THE APPARATUS.

## CAUTION!

- DO NOT INSTALL OR PLACE THIS UNIT IN A BOOKCASE, BUILT-IN CABINET OR IN ANOTHER CONFINED SPACE. ENSURE THE UNIT IS WELL VENTILATED. TO PREVENT RISK OF ELECTRIC SHOCK OR FIRE HAZARD DUE TO OVERHEATING, ENSURE THAT CURTAINS AND ANY OTHER MATERIALS DO NOT OBSTRUCT THE VENTILATION VENTS.
- DO NOT OBSTRUCT THE UNIT'S VENTILATION OPENINGS WITH NEWSPAPERS, TABLECLOTHS, CURTAINS, AND SIMILAR ITEMS.
- DO NOT PLACE SOURCES OF NAKED FLAMES, SUCH AS LIGHTED CANDLES, ON THE UNIT.
- DISPOSE OF BATTERIES IN AN ENVIRONMENTALLY FRIENDLY MANNER.

### For Australia and N.Z.

THIS UNIT IS INTENDED FOR USE IN MODERATE CLIMATES.

### For Asia and Middle East

THIS UNIT IS INTENDED FOR USE IN TROPICAL CLIMATES.

This product may receive radio interference caused by mobile telephones during use. If such interference is apparent, please increase separation between the product and the mobile telephone.

The socket outlet shall be installed near the equipment and easily accessible or the mains plug or an appliance coupler shall remain readily operable.

CLASS 1  
LASER PRODUCT





DANGER - VISIBLE AND INVISIBLE LASER RADIATION WHEN OPEN. AVOID DIRECT EXPOSURE TO BEAM. FDA 21 CFR Class IIIb	
注意	一 打开时有可见及不可见激光辐射。避免光束照射。
注意	一 ここを開くと可視及び不可視レーザー光が出ます。ビームを見たり、触れたりしないでください。
CAUTION - CLASS 3B VISIBLE AND INVISIBLE LASER RADIATION WHEN OPEN. AVOID EXPOSURE TO THE BEAM. IEC60825-1 +A2/Class 3B	
ATTENTION - RAYONNEMENT LASER VISIBLE ET INVISIBLE. CLASSE 3B. EN CAS D'OUVERTURE, ÉVITER UNE EXPOSITION AU FAISCEAU.	
FORSIGTIG - SYNLIG OG USYNLIG LASERSTRÅLING KLASSE 3B. NÅR LÅGET ER ÅBENT, UNDGÅ AT BLIVE UDSAT FOR STRÅLEN.	
VARO - AVATTAESSA OLET ALTIINTA LUOKAN 3B NÄKYVÄÄ JA NÄKYMÄTÖNTÄ LASERSÄTELYÄ, VÄRÄ ALTISTUMISTA SÄTEELLE.	
WARNING - KLASS 3B SYNLIG OCH USYNLIG LASERSTRÅLNING NÄR DENNA DEL ÄR ÖPPNAD. UNDIK EXPONERING FÖR STRÅLEN.	
VORSICHT - SICHTBARE UND UNSICHTBARE LASERSTRÄHLUNG KLASSE 3B. WENN ABDECKUNG GEÖFFNET, NICHT DEM STRAHL AUSSETZEN.	
CAUTION - VISIBLE AND INVISIBLE LASER RADIATION WHEN OPEN. AVOID EXPOSURE TO THE BEAM. (IEC60825-1)	
ATTENTION - RAYONNEMENT LASER VISIBLE ET INVISIBLE EN CAS D'OUVERTURE. EXPOSITION DANGEREUSE AU FAISCEAU.	
ADVARSEL - SYNLIG OG USYNLIG LASERSTRÅLING VED ÅBNING. UNDGÅ UDSÆTTELSE FOR STRÅLING.	
VARO! - AVATTAESSA OLET ALTIINTA NÄKYVÄÄ JA NÄKYMÄTÖN LASERSÄTELYLLE, ÄLÄ KATSO SÄTEESEEN.	
WARNING - SYNLIG OCH USYNLIG LASERSTRÅLNING NÄR DENNA DEL ÄR ÖPPNAD. BETRÄKTA EJ STRÅLEN.	
VORSICHT - SICHTBARE UND UNSICHTBARE LASERSTRÄHLUNG. WENN ABDECKUNG GEÖFFNET, NICHT DEM STRAHL AUSSETZEN.	
ADVARSEL - SYNLIG OG USYNLIG LASERSTRÅLING NÄR DEKSEL ÅPNES. UNNGÅ EKSPONERING FOR STRÅLEN. VOL1367	

(Inside of product)

Keep the small memory cards such as the SD Memory Card out of reach of children. If swallowed, seek medical advice immediately.

## Caution for AC Mains Lead

### (For Saudi Arabia)

For your safety, please read the following text carefully. This appliance is supplied with a moulded three pin mains plug for your safety and convenience. A 5-ampere fuse is fitted in this plug. Should the fuse need to be replaced please ensure that the replacement fuse has a rating of 5-ampere and that it is approved by ASTA or BSI to BS1362. Check for the ASTA mark  or the BSI mark  on the body of the fuse.

If the plug contains a removable fuse cover you must ensure that it is refitted when the fuse is replaced. If you lose the fuse cover the plug must not be used until a replacement cover is obtained. A replacement fuse cover can be purchased from your local dealer.

### CAUTION!

IF THE FITTED MOULDED PLUG IS UNSUITABLE FOR THE SOCKET OUTLET IN YOUR HOME THEN THE FUSE SHOULD BE REMOVED AND THE PLUG CUT OFF AND DISPOSED OF SAFELY. THERE IS A DANGER OF SEVERE ELECTRICAL SHOCK IF THE CUT OFF PLUG IS INSERTED INTO ANY 13-AMPERE SOCKET.

If a new plug is to be fitted please observe the wiring code as stated below. If in any doubt please consult a qualified electrician.

### IMPORTANT

The wires in this mains lead are coloured in accordance with the following code:  
 Blue: Neutral, Brown: Live.  
 As these colours may not correspond with the coloured markings identifying the terminals in your plug, proceed as follows:  
 The wire which is coloured Blue must be connected to the terminal which is marked with the letter N or coloured Black or Blue.  
 The wire which is coloured Brown must be connected to the terminal which is marked with the letter L or coloured Brown or Red.

**WARNING: DO NOT CONNECT EITHER WIRE TO THE EARTH TERMINAL WHICH IS MARKED WITH THE LETTER E, BY THE EARTH SYMBOL  OR COLOURED GREEN OR GREEN/YELLOW.**

**THIS PLUG IS NOT WATERPROOF—KEEP DRY.**

### Before use

Remove the connector cover.

### How to replace the fuse

The location of the fuse differ according to the type of AC mains plug (figures A and B). Confirm the AC mains plug fitted and follow the instructions below. Illustrations may differ from actual AC mains plug.

1. Open the fuse cover with a screwdriver.

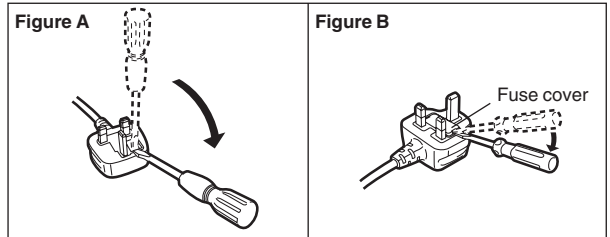

2. Replace the fuse and close or attach the fuse cover.

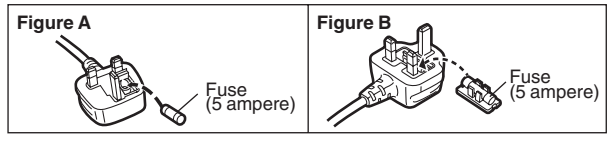

### -If you see this symbol-

#### Information on Disposal in other Countries outside the European Union



This symbol is only valid in the European Union. If you wish to discard this product, please contact your local authorities or dealer and ask for the correct method of disposal.

## Getting started

<b>HDD, disc and card information</b> .....	<b>4</b>
<b>Important notes for recording</b> .....	<b>8</b>
<b>HDD (Hard disk drive) handling care</b> .....	<b>9</b>
<b>Disc and card handling</b> .....	<b>10</b>
<b>Unit care</b> .....	<b>10</b>
<b>Included accessories</b> .....	<b>11</b>
<b>The remote control information</b> .....	<b>11</b>
<b>Control reference guide</b> .....	<b>12</b>
Remote control .....	12
Main unit .....	13
The unit's display .....	13
<b>STEP 1 Connection</b> .....	<b>14</b>
Connecting with an HDMI (High Definition Multimedia Interface) terminal .....	16
Control with HDMI (HDAVI Control™) .....	16
<b>STEP 2 Channel reception settings and TV aspect settings</b> .....	<b>17</b>
<b>STEP 3 Set up to match your television and remote control</b> .....	<b>18</b>
To enjoy progressive video .....	18

## Recording

<b>Recording television programmes</b> .....	<b>20</b>
Disc Insertion/Ejection .....	21
To specify a time to stop recording—One Touch Recording .....	22
Recording settings for High Speed Copy .....	22
Flexible Recording .....	23
Playing while you are recording .....	23
<b>Timer recording</b> .....	<b>24</b>
Using G-CODE system to make timer recordings .....	24
Manually programming timer recordings .....	25
To cancel recording when recording has already begun .....	26
To release the unit from recording standby .....	26
Notes on timer recording .....	26
Check, change or delete a programme .....	27
Relief Recording .....	27
Auto Renewal Recording .....	27

## Playing back

<b>Playing recorded video contents/</b>	
<b>Playing play-only discs</b> .....	<b>28</b>
Operations during play .....	29
Changing audio during play .....	30
<b>Playing DivX discs,</b>	
<b>MP3 discs and still pictures (JPEG/TIFF)</b> .....	<b>31</b>
Regarding DivX discs,	
MP3 discs and still pictures (JPEG/TIFF) .....	31
Selecting file type to play .....	32
Playing DivX discs .....	32
Playing MP3 discs .....	33
Playing still pictures .....	34
Useful functions during still picture play .....	35
<b>Using on-screen menus/Status message</b> .....	<b>36</b>
Using on-screen menus .....	36
Status messages .....	37

## Editing

<b>Editing titles/chapters</b> .....	<b>38</b>
Editing titles/chapters and playing chapters .....	38
Title operations .....	39
Chapter operations .....	39
<b>Creating, editing and playing playlists</b> .....	<b>40</b>
Creating playlists .....	40
Editing and playing playlists/chapters .....	41
Playlist operations .....	41
Chapter operations .....	41
<b>Editing still pictures</b> .....	<b>42</b>
Album and picture operation .....	43
<b>Delete Navigator</b> .....	<b>44</b>
Using the DELETE Navigator to delete .....	44
Deleting titles or pictures during play .....	44

## Copying

<b>Copying titles or playlists</b> .....	<b>45</b>
Copy .....	46
Copying using the copying list—Advanced Copy .....	47
Copying a finalized DVD-R, DVD-R DL, DVD-RW (DVD-Video format), +R and +R DL .....	49
Copying MPEG2 moving pictures from an SD card .....	49
<b>Copying still pictures</b> .....	<b>50</b>
Copying using the copying list .....	50
Copying all the still pictures on a card—Copy All Pictures .....	51
<b>Copying from a video cassette recorder</b> .....	<b>52</b>
Manual recording .....	52
DV automatic recording (DV Auto Rec) .....	52

## Convenient functions

<b>HDD, disc and card management</b> .....	<b>53</b>
Common procedures .....	53
Setting the protection .....	53
Providing a name for a disc .....	53
Deleting all titles and playlists—Delete all titles .....	54
Deleting all the contents of a disc or card—Format .....	54
Selecting the background style—Top Menu .....	55
Selecting whether to show the Top Menu first	
—Auto-Play Select .....	55
Enabling discs to be played on other equipment	
—Finalize .....	55
Creating Top Menu—Create Top Menu .....	55
<b>Entering text</b> .....	<b>56</b>
<b>FUNCTIONS window</b> .....	<b>57</b>
<b>Child Lock</b> .....	<b>57</b>
<b>Changing the unit's settings</b> .....	<b>58</b>
Common procedures .....	58
Summary of settings .....	59
Tuning .....	62
TV System .....	63
Clock Settings .....	64

## Reference



<b>Messages</b> .....	<b>65</b>
<b>Frequently asked questions</b> .....	<b>67</b>
<b>Troubleshooting guide</b> .....	<b>68</b>
<b>Glossary</b> .....	<b>73</b>
<b>Specifications</b> .....	<b>74</b>
<b>Safety precautions</b> .....	<b>75</b>
<b>Index</b> .....	<b>Back cover</b>

## HDD and discs you can use for recording and play

Disc type	Hard disk drive (HDD) ●250 GB	DVD-RAM ●4.7 GB/9.4 GB, 12 cm ●2.8 GB, 8 cm
Logo	-	
Indicated in these instructions by	<b>HDD</b>	<b>RAM</b>
Recording format	<b>DVD Video Recording format</b> This is a recording method which allows you to record and edit television broadcasts and so on. ●You can delete unwanted parts of a title, create playlists, etc. ●Digital broadcasts that allow “One time only recording” can be recorded to a CPRM compatible disc.	
Data that can be recorded and played	Video Still pictures	Video Still pictures
Re-writable* <sup>1</sup>	✓	✓
Play on other players* <sup>2</sup>	-	Only on DVD-RAM compatible players.
Compatible with high speed recording* <sup>3</sup>	-	Up to 5X recording speed discs.

### What you can do on this unit (✓: Can do, ✗: Cannot do)

Recording broadcasts that allow one copy	✓	✓ [CPRM (⇒ 73) compatible discs only.]
Recording both M 1 and M 2 for bilingual broadcasts* <sup>4</sup>	✓	✓
Recording 16:9 aspect picture* <sup>4</sup>	✓	✓
Creating and editing playlists	✓	✓

Disc type	DVD-R ●4.7 GB, 12 cm ●1.4 GB, 8 cm	DVD-R DL (dual layer on single side) ●You cannot directly record to a DVD-R DL disc on this unit (⇒ 8)	DVD-RW ●4.7 GB, 12 cm ●1.4 GB, 8 cm
Logo			
Indicated in these instructions by	<b>-R</b> before finalization <b>DVD-V</b> after finalization	<b>-R DL</b> before finalization <b>DVD-V</b> after finalization	<b>-RW(V)</b> before finalization <b>DVD-V</b> after finalization
Recording format	<b>DVD-Video format</b> This recording method is the same as commercially available DVD-Video. ●Digital broadcasts that allow “One time only recording” cannot be recorded.		
Data that can be recorded and played	Video	Video	Video
Re-writable* <sup>1</sup>	✗	✗	✓
Play on other players* <sup>2</sup>	Only after finalizing the disc (⇒ 55, 73).	Only on DVD-R DL compatible players after finalizing the disc (⇒ 55, 73).	Only after finalizing the disc (⇒ 55, 73).
Compatible with high speed recording* <sup>3</sup>	Up to 16X recording speed discs.	Up to 4X recording speed discs.	Up to 6X recording speed discs.

### What you can do on this unit (✓: Can do, ✗: Cannot do)

Recording broadcasts that allow one copy	✗	✗	✗
Recording both M 1 and M 2 for bilingual broadcasts* <sup>4</sup>	✗ [Only one is recorded.(⇒ 60, Bilingual Audio Selection)]	✗ [Only one is recorded.(⇒ 60, Bilingual Audio Selection)]	✗ [Only one is recorded.(⇒ 60, Bilingual Audio Selection)]
Recording 16:9 aspect picture* <sup>4</sup>	✗ (The picture is recorded in 4:3 aspect.)	✗ (The picture is recorded in 4:3 aspect.)	✗ (The picture is recorded in 4:3 aspect.)
Creating and editing playlists	✗	✗	✗

# HDD and discs you can use for recording and play

(continued)

Disc type	+R <sup>*5</sup> ● 4.7 GB, 12 cm	+R DL (double layer on single side) ● You cannot directly record to a +R DL disc on this unit (⇒ 8)	+RW
Logo	—	—	—
Indicated in these instructions by	+R before finalization	+R DL before finalization	+RW
	DVD-V after finalization	DVD-V after finalization	
Recording format	<b>+VR (+R/+RW Video Recording) format</b> This is a method for recording moving pictures to +R/+RW discs. You can playback such discs recorded in this method in a similar way as contents recorded in the DVD-Video format. ● Digital broadcasts that allow “One time only recording” cannot be recorded. ● After finalizing the disc or creating the top menu, you can play the disc on DVD players and other equipment.		
Data that can be recorded and played	Video	Video	Video
Re-writable <sup>*1</sup>	×	×	✓
Play on other players <sup>*2</sup>	Only after finalizing the disc (⇒ 55, 73).	Only on +R DL compatible players after finalizing the disc (⇒ 55, 73).	Only on +RW compatible players.
Compatible with high speed recording <sup>*3</sup>	Up to 16X recording speed discs.	Up to 2.4X recording speed discs.	Up to 4X recording speed discs. <sup>*6</sup>
<b>What you can do on this unit (✓: Can do, ×: Cannot do)</b>			
Recording broadcasts that allow one copy	×	×	×
Recording both M 1 and M 2 for bilingual broadcasts <sup>*4</sup>	×	×	×
Recording 16:9 aspect picture <sup>*4</sup>	×	×	×
Creating and editing playlists	×	×	×

\*1 The amount of the recordable disc space doesn't increase even if the programme is deleted when you use one time recording disc.

\*2 **RAM** Can be played on Panasonic DVD Recorders and DVD-RAM compatible DVD players.

If you play a DVD-R DL, +R DL or +RW, use compatible equipment.

\*3 The high speed recording discs listed here are compatible with this unit. However, this is not the copy speed.

\*4 For further information (⇒ 8, Important notes for recording)

\*5 +R discs recorded with this unit and +R discs recorded with another Panasonic DVD Recorder may be incompatible. However, discs that are finalized are compatible and can be played.

\*6 You can play 8X recording speed discs recorded on another equipment.

- We recommend using Panasonic discs and cards. We also recommend using DVD-RAM discs with cartridges to protect them from scratches and dirt.
- You may not be able to record depending on the condition of the discs and you may not be able to play due to the condition of the recording.
- You cannot record programmes that allow “One time only recording” to CPRM compatible DVD-R and DVD-RW on this unit. You can record other programmes as DVD-Video format.
- This unit cannot record to discs containing both PAL and NTSC signals. (However, both types of programmes can be recorded onto the HDD.) Play of discs recorded with both PAL and NTSC on another unit is not guaranteed.

**Note**

When “Rec for High Speed Copy” is set to “On”, the restrictions on secondary audio recording etc. are also applied to DVD-RAM. Turn this setting “Off” if high speed copy to DVD-R, etc. is not necessary when recording a programme (⇒ 22).

**Finalize**

A process that makes play of a recorded disc possible on equipment that can play such media. After finalizing, the disc becomes play-only and you can no longer record or edit. (⇒ 55)

**Formatting**

Formatting is the process of making media such as DVD-RAM recordable on recording equipment. (⇒ 54)

**You cannot directly record to a DVD-R DL and +R DL disc on this unit.**



Record to the HDD and then copy to the disc.

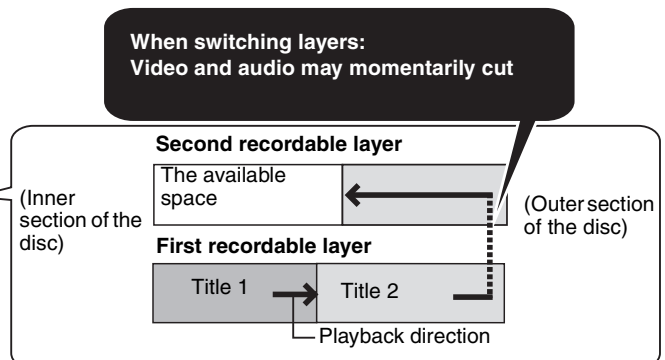

**When playing DVD-R DL (Dual Layer, single-sided) and +R DL (Double Layer, single-sided)**

DVD-R DL (Dual Layer, single-sided) and +R DL (Double Layer, single-sided) discs have two writable layers on one side. If there is not enough space on the first layer to record a programme, the balance is recorded on the second layer. When playing a title recorded on both layers, the unit automatically switches between layers and plays the title in the same way as a normal programme. However, video and audio may momentarily cut out when the unit is switching layers.



## Play-only discs (12 cm/8 cm)

Disc type	DVD-Video	DVD-Audio	DVD-RW (DVD Video Recording format)
Logo			
Indicated in these instructions by	<b>DVD-V</b>	<b>DVD-A</b>	<b>-RW(VR)</b>
Instructions	High quality movie and music discs	High fidelity music discs ● Played on this unit in 2 channels.	DVD-RW recorded on another DVD Recorder ● You can play programmes that allow "One time only recording" if they have been recorded to a CPRM compatible disc. ● By formatting (⇒ 54) the disc, you can record to it in DVD-Video format and play it on this unit. ● It may be necessary to finalize the disc on the equipment used for recording.

Disc type	DVD-R	CD	Video CD
Logo			
Indicated in these instructions by	<b>DivX</b>	<b>CD</b>	<b>VCD</b>
Instructions	● DVD-R* with video recorded in DivX	Recorded audio and music (including CD-R/RW*)	Recorded music and video (including CD-R/RW*)

\*Close the session after recording. Play may be impossible on some discs due to the condition of the recording.

- The producer of the disc can control how discs are played. So you may not always be able to control play as described in these operating instructions. Read the disc's instructions carefully.
- Operation and sound quality of CDs that do not conform to CD-DA specifications (copy control CDs, etc.) cannot be guaranteed.

### Regarding DVD-Audio

Some multi-channel DVD-Audio will prevent down-mixing (⇒ 73) of all or part of their contents if this is the manufacturer's intention. Tracks that are prevented from being down-mixed will not play properly on this unit (e.g. audio is played from the front two channels only). Refer to the disc's jacket for more information.

## Discs that cannot be played

- 2.6 and 5.2 GB DVD-RAM, 12 cm
- 3.95 and 4.7 GB DVD-R for Authoring
- DVD-R recorded in DVD Video Recording format
- DVD-R (DVD-Video format), DVD-R DL, DVD-RW (DVD-Video format), +R, +R DL recorded on another unit and not finalized (⇒ 73).
- **For Asia** DVD-Video with a region number other than "3" or "ALL"
- **For Australia and N.Z.** DVD-Video with a region number other than "4" or "ALL"
- **For Middle East** DVD-Video with a region number other than "2" or "ALL"
- Blu-ray
- DVD-ROM, +R (8 cm), CD-ROM, CDV, CD-G, Photo CD, CVD, SVCD, SACD, MV-Disc, PD, etc.

## Types of disc or title recorded on HDD for the type of connected TV

When you use the discs recorded either PAL or NTSC, or playback a title recorded on HDD using PAL or NTSC, refer to this table.  
(√: Possible to view, X: Impossible to view)

TV type	Disc/Titles recorded on HDD	Yes/No
Multi-system TV	PAL	√
	NTSC	√*1
NTSC TV	PAL	X
	NTSC	√*2
PAL TV	PAL	√
	NTSC	√*3 (PAL60)

\*1 If you select "NTSC" in "TV System" (⇒ 63), the picture may be clearer.

\*2 Select "NTSC" in "TV System" (⇒ 63).

\*3 If your television is not equipped to handle PAL 525/60 signals the picture will not be shown correctly.

● When playing back a title recorded on the HDD, ensure that you match the "TV System" setting to the title (⇒ 63).



## Cards you can use on this unit

Type	SD Memory Card miniSD™ Card* MultiMediaCard
Indicated in these instructions by	<b>SD</b>
Data that can be recorded and played	Still pictures Video (MPEG2)
Instructions	<p>You can insert directly into the SD card slot.</p> <p>* A miniSD™ card adaptor included with the miniSD™ card is necessary.</p> <ul style="list-style-type: none"> <li>• You can play and copy still pictures taken on a digital camera etc. (⇒ 34, 50).</li> <li>• You can set the DPOF (Digital Print Order Format) for automatic printing on your home printer or at a photo developing store (⇒ 43, 73).</li> <li>• MPEG2 moving pictures shot with a Panasonic SD Video camera, etc. can be copied to the HDD or DVD-RAM. (⇒ 49)</li> <li>• MPEG2 moving pictures cannot be played directly from the SD card.</li> </ul>

• Compatible with: FAT 12 or FAT 16

### Suitable SD Memory Cards

• You can use SD Memory Cards with the following capacities (from 8 MB to 2 GB).

8 MB, 128 MB,	16 MB, 256 MB,	32 MB, 512 MB,	64 MB, 1 GB,	2 GB (Maximum)
------------------	-------------------	-------------------	-----------------	----------------

- Useable memory is slightly less than the card capacity.
- Please confirm the latest information on the following website.  
<http://panasonic.co.jp/pavc/global/cs>  
(This site is in English only.)

- If the SD Memory Card is formatted on other equipment, the time spent for recording may become longer. Also if the SD Memory Card is formatted on a PC, you may not be able to use it on this unit. In these cases, format the card on this unit (⇒ 54, 73).
- This unit supports SD Memory Cards formatted in FAT 12 system and FAT 16 system based on SD Memory Card Specifications.
- We recommend using a Panasonic SD card.

### Structure of folders displayed by this unit

The following  can be displayed on this unit.

\*\*\*: Numbers      XXX: Letters

#### DVD-RAM

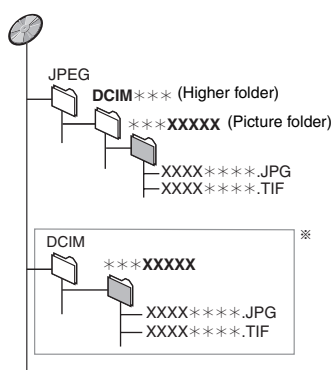



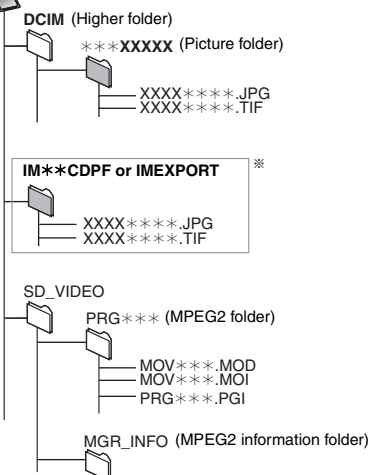







#### Card

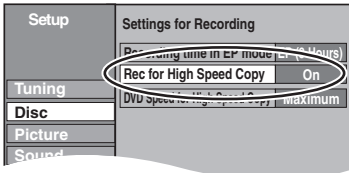

\* Folders can be created on other equipment. However, these folders cannot be selected as a copying destination.

• The folder cannot be displayed if the numbers are all "0" (e.g., DCIM000, etc.).

• If a folder name or file name has been input using other equipment, the name may not be displayed properly or you may not be able to play or edit the data.

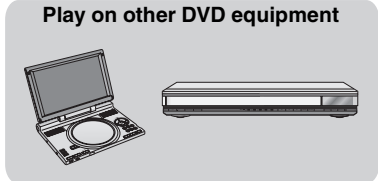
<p><b>When recording a bilingual programme</b></p>	<p><b>HDD RAM</b>  <b>Both main and secondary audio can be recorded.</b>          You can change the audio during playback.          (⇒ 30, Changing audio during play)</p> <p>However in the following cases, select whether to record the main or secondary audio:          –Recording sound in LPCM (⇒ 60, Audio Mode for XP Recording)          –“Rec for High Speed Copy” is set to “On” (⇒ 22)</p> <div style="display: flex; justify-content: space-around;"> <div style="text-align: center;"> <p>M 1</p> <p>Hello</p>  </div> <div style="text-align: center;"> <p>M 2</p> <p>Hallo</p>  </div> </div> <p>If you record from external equipment          –Select both “M 1” and “M 2” on the external equipment.</p> <div style="display: flex; justify-content: space-between; align-items: flex-start;"> <div style="text-align: center;"> <p><b>-R -RW(V) +R +RW</b></p> <p><b>Select the main or secondary audio before recording</b>              (⇒ 60, Bilingual Audio Selection)</p> <p>M 1</p> <p>Hello</p>  <p><b>The selected audio only is recorded.</b></p> </div> <div style="text-align: center;"> <p>If you record from external equipment              –Select “M 1” or “M 2” on the external equipment.</p> </div> </div>
<p><b>When recording 16:9 aspect (Widescreen) programmes</b></p>	<p><b>HDD RAM</b></p> <p><b>16:9 aspect (Widescreen)</b></p>  <p><b>-R -RW(V) +R +RW</b></p> <p><b>Recorded in 4:3 aspect</b></p> 
<p><b>When you want to copy titles in high speed mode from the HDD to DVD-R, etc.</b></p>	<p><b>Set “Rec for High Speed Copy” to “On” before recording to the HDD (⇒ 22).</b>          You can copy titles in high speed mode (max. speed is 86X*); however, the following settings are necessary before recording to the HDD.          * Depending on the disc, max. speed may vary.</p> <div style="display: flex; align-items: center;">  <div style="margin-left: 20px;"> <p><b>Record to the HDD</b></p>  <p><b>High speed copy to DVD-R, etc.</b></p> </div> </div>
<p><b>When recording digital broadcasts</b></p>	<p>It is not possible to record digital broadcasts that allow “One time only recording” onto DVD-R, DVD-RW, +R, +RW or 8 cm DVD-RAM discs. Use the HDD or CPRM (⇒ 73) compatible DVD-RAM.</p> <p><b>RAM</b> CPRM compatible discs only.</p> <div style="display: flex; align-items: center; justify-content: space-around;"> <div style="text-align: center;"> <p><b>HDD</b></p>  </div> <div style="text-align: center;"> <p><b>-R -RW(V) +R +RW</b></p>  </div> </div> <p>(✓: Can do, X: Cannot do)</p> <ul style="list-style-type: none"> <li>• “One time only recording” titles can only be transferred from the HDD to CPRM compatible DVD-RAM (They are deleted from the HDD). They cannot be copied.</li> <li>• Even when copying to videotape the title may not be copied correctly because of the copy guard.</li> <li>• You cannot copy a playlist created from “One time only recording” titles.</li> </ul>
<p><b>Playing the disc on other DVD players</b></p>	<p><b>-R -R DL -RW(V) +R +R DL</b></p> <p><b>The disc must be finalized after recording or copying (⇒ 55).</b>          It is necessary to finalize DVD-R, etc. on this unit after recording or copying titles to them. You can then play them as a commercially sold DVD-Video. However, the discs become play-only and you can no longer record or copy.*          *You can record and copy again if you format DVD-RW.</p> <div style="display: flex; align-items: center; justify-content: center;">  <div style="margin-left: 20px;"> <p><b>Record to DVD-R, etc.</b></p>  <p><b>Finalize</b></p> </div> <div style="margin-left: 20px;"> <p><b>Play on other DVD equipment</b></p>  </div> </div>
<p><b>Recording to DVD-R DL and +R DL</b></p>	<p><b>You cannot directly record to a DVD-R DL and +R DL disc on this unit.</b>          Record to the HDD and then copy to the disc.</p>

• It is not possible to record to both HDD (Hard Disk Drive) and DVD drive simultaneously.



# HDD (Hard disk drive) handling care

The HDD is a high precision recording instrument and because of its long recording capability and high speed operation it is a very special device that is easily susceptible to damage.

As a basic rule, save important content to a disc as backup.

## ■ The HDD is a device that is not built to withstand vibration/shock or dust

Depending on the setup environment and handling of the HDD some content may become damaged and play and recording may no longer be possible. Especially during operation, do not subject the unit to any vibration, shock, or remove the AC mains lead from the household mains socket. In the event of a power failure during recording or play, the content may be damaged.

## ■ The HDD is a temporary storage device

The HDD is not an everlasting storage device for recorded content. Use the HDD as a temporary storage place for one-off viewing, editing, or saving recorded content to a disc.

## ■ Immediately save (backup) all content as soon as you feel there may be a problem with the HDD

If there is an irregularity within the HDD, repetitive strange sounds or problems with picture (block noise, etc.) may result. Using the HDD in this condition may worsen the problem and in the worst case the HDD may no longer become usable. As soon as you notice this type of problem, copy all content to disc and request service. Recorded content (data) on a HDD that has become unusable is unrecoverable.

- When the HDD has been automatically placed in the SLEEP mode (➡ below), or the unit is turned on or off, there may be an unexpected sound. This does not indicate a problem with this unit.

### ■ Setup precautions

- Do not place in an enclosed area so the rear cooling fan and the cooling vents on the side are covered up.
- Place the unit on a surface that is flat and not subject to vibration or impact.
- Do not place on anything that generates heat like a video cassette recorder, etc.
- Do not place in an area often subject to temperature changes.
- Place in an area where condensation does not occur. Condensation is a phenomenon where moisture forms on a cold surface when there is an extreme change in temperature. Condensation may cause internal damage to the unit.
- Conditions where condensation may occur
  - When there is an extreme change in temperature (moving from a very hot location to a very cold location, or vice versa, or when subjected to an air conditioner or when cooled air directly impacts the unit). When the HDD (warms during operation) is subjected to cold air, condensation may form on the inside of the HDD and may cause damage to the HDD heads, etc.
  - When there is high humidity or a lot of steam in the room.
  - During the rainy season.



In the above situation, **without turning the unit on**, let the unit adjust to the room temperature and wait 2–3 hours until condensation is gone.

### ■ Cigarette smoke etc. causes malfunction or breakdown

The unit may breakdown if cigarette smoke or bug spray/vapor, etc. gets inside the unit.

### ■ While operating

- Do not move the unit or subject to vibration or impact. (The HDD may become damaged.)
  - Do not remove the AC mains lead from the household mains socket, or flip the power breaker switch.
- While the unit is on, the HDD is rotating at high speed. Sound or movement due to rotation is normal.

### ■ When moving the unit

- ① Turn the unit off. (Wait until “BYE” disappears from the display.)
- ② Remove the AC mains lead from the household mains socket.
- ③ Move only after the unit has come to a complete stop (approx. 2 minutes) in order to avoid subjecting to vibration and shock. (Even after turning the unit off, the HDD continues operating for a short time.)

### ■ HDD recording time remaining

This unit records using a VBR (Variable bit rate) data compression system to vary recorded data segments to match video data segments which may cause differences in the displayed amount of time and space remaining for recording.

If the remaining amount of time is insufficient, delete any unwanted titles to create enough space before you start recording. (Deleting a playlist will not increase the amount of time.)

### ■ When “SLEEP” appears on the unit’s display

The HDD has been automatically placed in the SLEEP mode. (The HDD continues to rotate at high speed while the unit is on. In order to extend the life of the HDD, the HDD will be placed in the SLEEP mode if no operation has been performed for 30 minutes while there is no disc on the disc tray.)

- While in SLEEP mode play or recording may not start right away because the HDD takes time to be re-activated.
- When not using the unit, we recommend removing the disc in the tray in order to set the HDD to the SLEEP mode.

### ■ Indemnity concerning recorded content

Panasonic does not accept any responsibility for damages directly or indirectly due to any type of problems that result in loss of recording or edited content (data), and does not guarantee any content if recording or editing does not work properly. Likewise, the above also applies in a case where any type of repair is made to the unit (including any other non-HDD related component).

# Disc and card handling

## ■ How to hold a disc or card

Do not touch the recorded surface or the terminal surface.

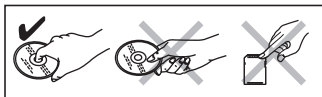

## ■ Concerning non-cartridge discs

Be careful about scratches and dirt.

## ■ If there is dirt or condensation on the disc

Wipe with a damp cloth and then wipe dry.



## ■ Handling precautions

- Do not attach labels or stickers to discs. (This may cause disc warping and un-balanced rotation, rendering it unusable.)
- Write on the label side of the disc only with a soft, oil-based felt pen. Do not use ballpoint pens or other hard writing implements.
- Do not use record cleaning sprays, benzine, thinner, static electricity prevention liquids or any other solvent.
- Do not use scratch-proof protectors or covers.
- Do not expose the terminals of the card to water, garbage or other strange things.
- Do not drop stack, or impact discs. Do not place objects on them.
- Do not use the following discs:
  - Discs with exposed adhesive from removed stickers or labels (rental discs, etc.).
  - Discs that are badly warped or cracked.
  - Irregularly shaped discs, such as heart shapes.

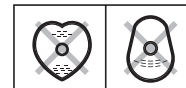

- Do not place in the following areas:
  - In direct sunlight.
  - In very dusty or humid areas.
  - Near a heater.
  - Locations susceptible to significant difference in temperature (condensation can occur).
  - Where static electricity or electromagnetic waves occur.
- To protect discs from scratches and dirt, return them to their cases or cartridges when you are not using them.

**The manufacturer accepts no responsibility and offers no compensation for loss of recorded or edited material due to a problem with the unit or recordable media, and accepts no responsibility and offers no compensation for any subsequent damage caused by such loss.**

**Examples of causes of such losses are**

- A disc recorded and edited with this unit is played in a DVD Recorder or computer disc drive manufactured by another company.
- A disc used as described above and then played again in this unit.
- A disc recorded and edited with a DVD Recorder or computer disc drive manufactured by another company is played in this unit.

## Unit care

The precision parts in this unit are readily affected by the environment, especially temperature, humidity, and dust. Cigarette smoke also can cause malfunction or breakdown.

To clean this unit, wipe with a soft, dry cloth.

- Never use alcohol, paint thinner or benzine to clean this unit.
- Before using chemically treated cloth, carefully read the instructions that came with the cloth.

Observe the following points to ensure continued listening and viewing pleasure.

Dust and dirt may adhere to the unit's lens over time, making it impossible to record or play discs.

Use the **DVD lens cleaner** about once every year, depending on frequency of use and the operating environment. Carefully read the lens cleaner's instructions before use.

DVD lens cleaner: RP-CL720E

**Do not place the unit on amplifiers or equipment that may become hot.**

The heat can damage the unit.

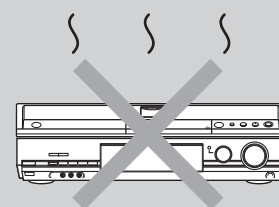

### Note

Do not obstruct the rear panel's internal cooling fan.

**Before moving the unit, ensure the disc tray is empty. Failure to do so will risk severely damaging the disc and the unit.**

# Included accessories



Please check and identify the supplied accessories.  
(Product numbers correct as of April 2006. These may be subject to change.)



**For Asia and Middle East**

**1 Remote control**



(EUR7659YE0)



**For Asia**

**1 AC mains lead**



**2 RF coaxial cables**



**2 Batteries**  
for remote control

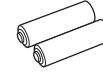

**1 Audio/video cable**



**For Australia and N.Z.**

**1 Remote control**



(EUR7659YD0)

**For Australia and N.Z.**

**1 AC mains lead**



**For Middle East**

**2 AC mains lead**



**For Saudi Arabia**

- For use with this unit only. Do not use it with other equipment. Also, do not use cords for other equipment with this unit.

## The remote control information

### Batteries

- Insert so the poles (+ and -) match those in the remote control.
- When closing the lid, insert it from the - (minus) side.

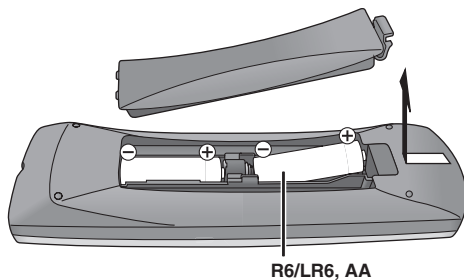

- Do not use rechargeable type batteries.
- Do not mix old and new batteries.
- Do not use different types at the same time.
- Do not heat or expose to flame.
- Do not take apart or short circuit.
- Do not attempt to recharge alkaline or manganese batteries.
- Do not use batteries if the covering has been peeled off.

Mishandling of batteries can cause electrolyte leakage which can damage items the fluid contacts and may cause a fire.

Remove if the remote control is not going to be used for a long period of time. Store in a cool, dark place.

Remote control operations (⇒ 12)

### Note

If you cannot operate the unit or television using the remote control after changing the batteries, please re-enter the codes (⇒ 19).

### Use

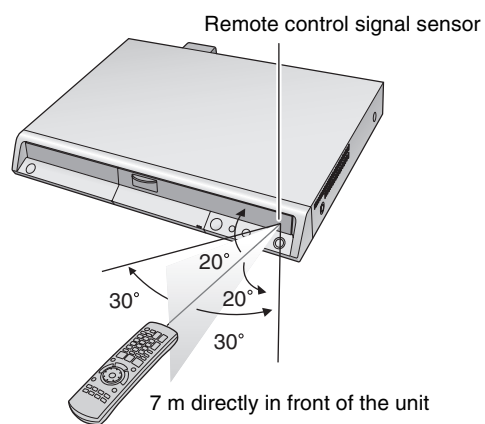

## Remote control

Instructions for operations are generally described using the remote control.

e.g., **Australia and N.Z.**

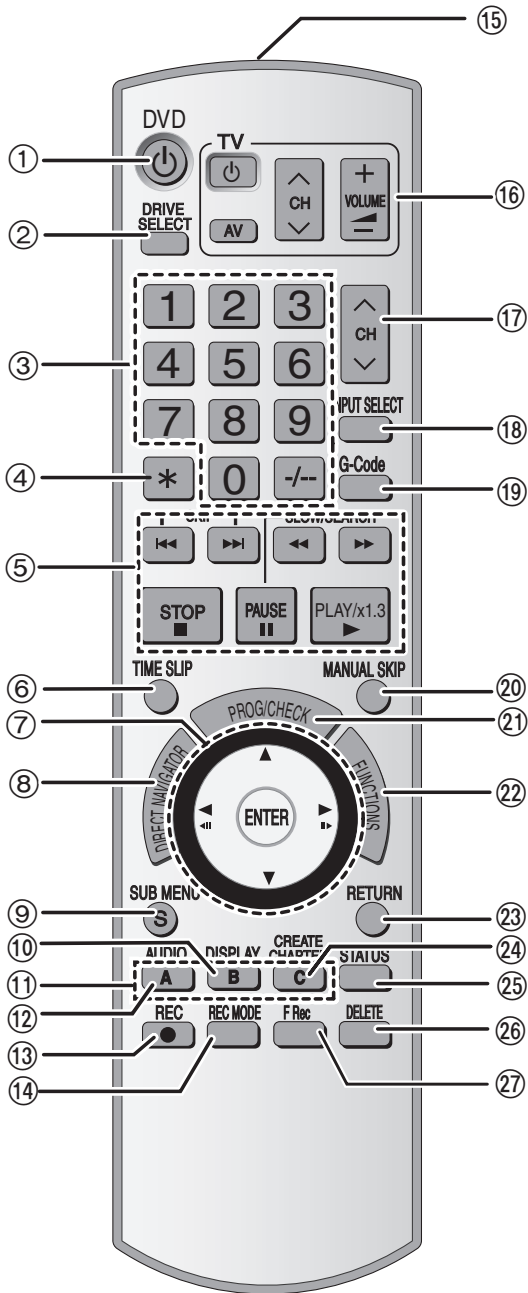

- ① Turn the unit on (⇒ 17)
- ② Select drive (HDD, DVD or SD) (⇒ 20, 28, 34)
- ③ Select channels and title numbers, etc./Enter numbers
- ④ Cancel
- ⑤ Basic operations for recording and play
- ⑥ Skip the specified time (⇒ 30)
- ⑦ Selection/Enter, Frame-by-frame (⇒ 30)
- ⑧ Show Top menu/Direct Navigator (⇒ 28, 29, 38)
- ⑨ Show sub menu (⇒ 38)
- ⑩ Show on-screen menu (⇒ 36)
- ⑪ Buttons for switching between Video/Picture and Video/Playlists, manual tuning settings (⇒ 28, 47, 62)
- ⑫ Select audio (⇒ 30)
- ⑬ Start recording (⇒ 20)
- ⑭ Change recording mode (⇒ 20)
- ⑮ Transmit the remote control signal
- ⑯ Television operations (⇒ 19)
- ⑰ Channel select (⇒ 20)
- ⑱ Input select (AV1, AV2, AV3, AV4 or DV) (⇒ 52)
- ⑲ **For Australia and N.Z.** Show G-CODE screen (⇒ 24)
- ⑳ Skip 30 seconds forward (⇒ 30)
- ㉑ Show timer recording programme screen (⇒ 25)
- ㉒ Show FUNCTIONS window (⇒ 57)
- ㉓ Return to previous screen
- ㉔ Create chapter (⇒ 30)
- ㉕ Show status messages (⇒ 37)
- ㉖ Delete items (⇒ 44)
- ㉗ Flexible Recording (⇒ 23)

## Main unit

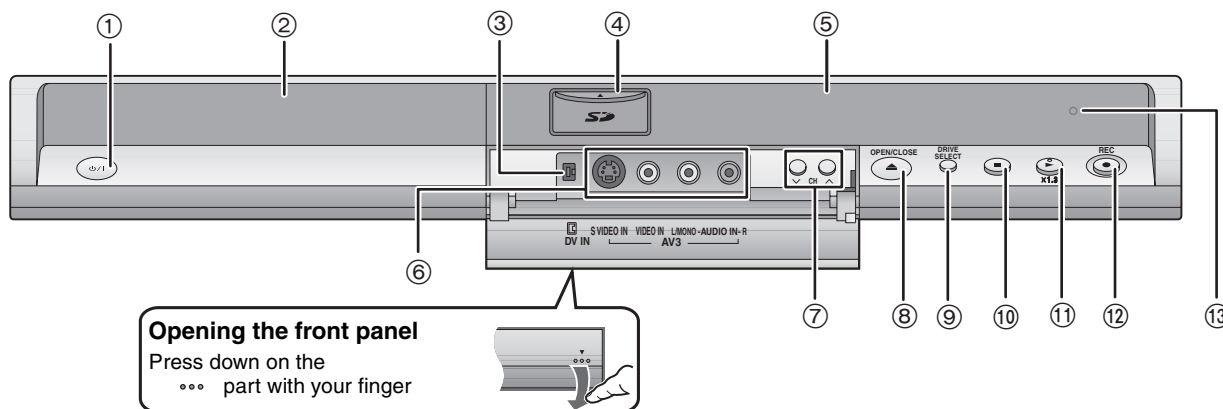

### Opening the front panel

Press down on the  
... part with your finger

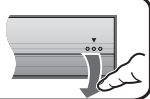



- ① **Standby/on switch (⏻/⏻) (⇒ 17)**  
Press to switch the unit from on to standby mode or vice versa. In standby mode, the unit is still consuming a small amount of power.
  - ② **Disc tray (⇒ 20, 28)**
  - ③ **Connection for digital video (DV) camcorder (⇒ 52)**
  - ④ **SD card slot (⇒ below)**
  - ⑤ **Display (⇒ below)**
  - ⑥ **Connection for camcorder etc. (⇒ 52)**
  - ⑦ **Channel select (⇒ 20)**
  - ⑧ **Open/close disc tray (⇒ 20, 28)**
  - ⑨ **Select drive (⇒ 20, 28, 34)**  
Drive changes each time you press [DRIVE SELECT].
  - ⑩ **Stop (⇒ 20, 29)**
  - ⑪ **Start play (⇒ 28)**
  - ⑫ **Start recording (⇒ 20)/Specify a time to stop recording (⇒ 22)**
  - ⑬ **Remote control signal sensor**
- Rear panel terminals (⇒ 14–16)

## Inserting, Removing the SD card

When the card indicator (“SD”) on the unit’s display is flashing, the card is being read from or written to. Do not turn off the unit or remove the card. Such action may result in malfunction or loss of the card’s contents.

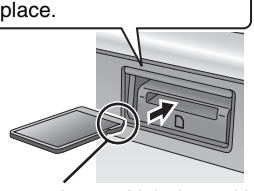
- **Inserting foreign objects can cause a malfunction.**
- You can use SD Memory Cards with capacities from 8 MB to 2 GB (⇒ 7).

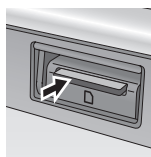
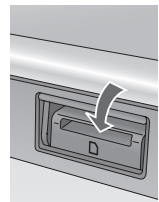
Opening the cover	Inserting the card	Removing the card	Closing the cover
<p>Press the protruding part to open the cover.</p> 	<p>Press on the centre of the card until it clicks into place.</p>  <p>Insert the card label up with the cut-off corner on the right. (Do not forget to close the cover. ⇒ right)</p>	<p>If you are using a miniSD™ card, insert it into the miniSD™ card adaptor that comes with the card. Insert and remove this adaptor from the unit.</p>  <p>① Press on the centre of the card. ② Pull it straight out.</p> 	<p>Press down.</p> 

### Automatic drive select function

- If you insert an SD card while the unit is stopped, the “SD Card” screen is displayed. Select an item and press [ENTER] to switch to the SD drive (⇒ 34, 50).
- If you remove an SD card, the HDD drive is automatically selected.

## The unit’s display

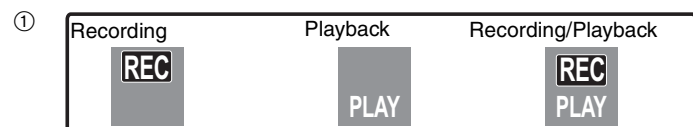
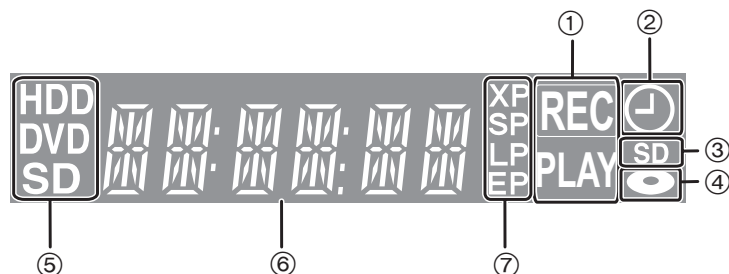

- ① **Recording**
- ② **Timer recording indicator**
- ③ **Lights when the SD card is inserted in the card slot.**
- ④ **Lights when a disc that is supported by this unit is inserted in the tray.**
- ⑤ **Lights when the HDD, DVD or SD drive is selected**
- ⑥ **Main display section**
- ⑦ **Recording mode**

# STEP 1 Connection

## Make sure to use the pair of supplied RF coaxial cables

Use the pair of supplied RF coaxial cables only when you make connections to the unit through its RF IN and RF OUT terminals. Striping may appear and disrupt images on the TV if you use different cables for connection.

- Before connection, turn off all equipment and read the appropriate operating instructions.
- Select the connection pattern that matches your environment from pattern A–B. Confirm connections not listed below with your dealer.

## When the unit is not to be used for a long time

To save power, unplug it from the household mains socket. This unit consumes a small amount of power, even when it is turned off [approx. 2 W (Power Save mode)]

When "Power Save" is set to "On", the "Quick Start" function does not work.

### A Connecting a television

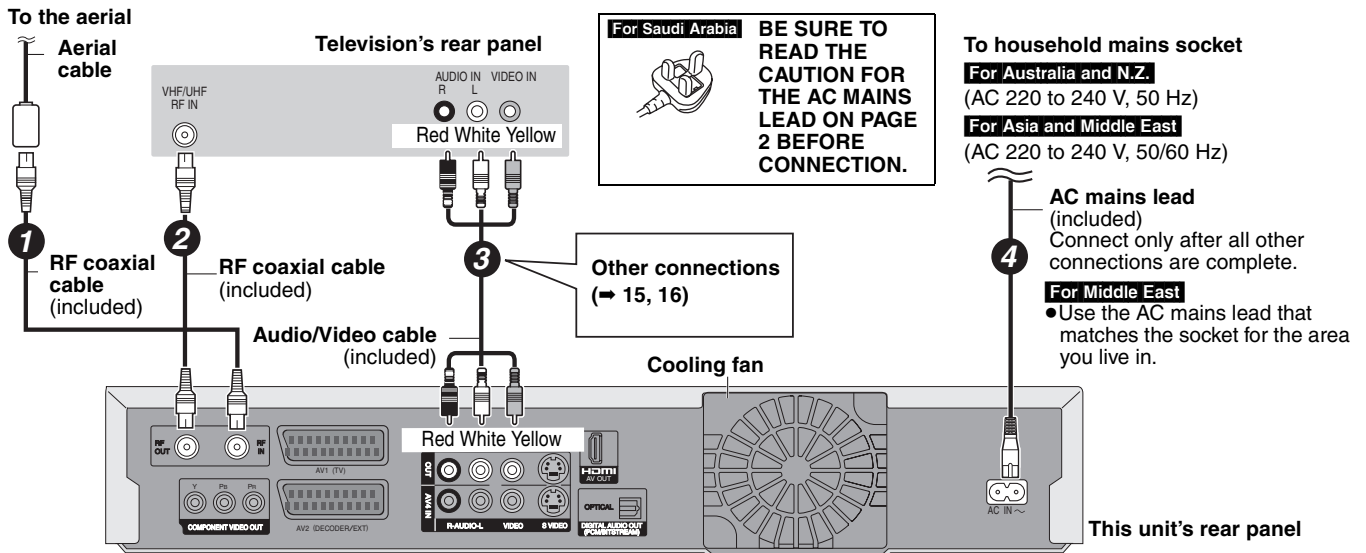

### B Connecting a television and VCR

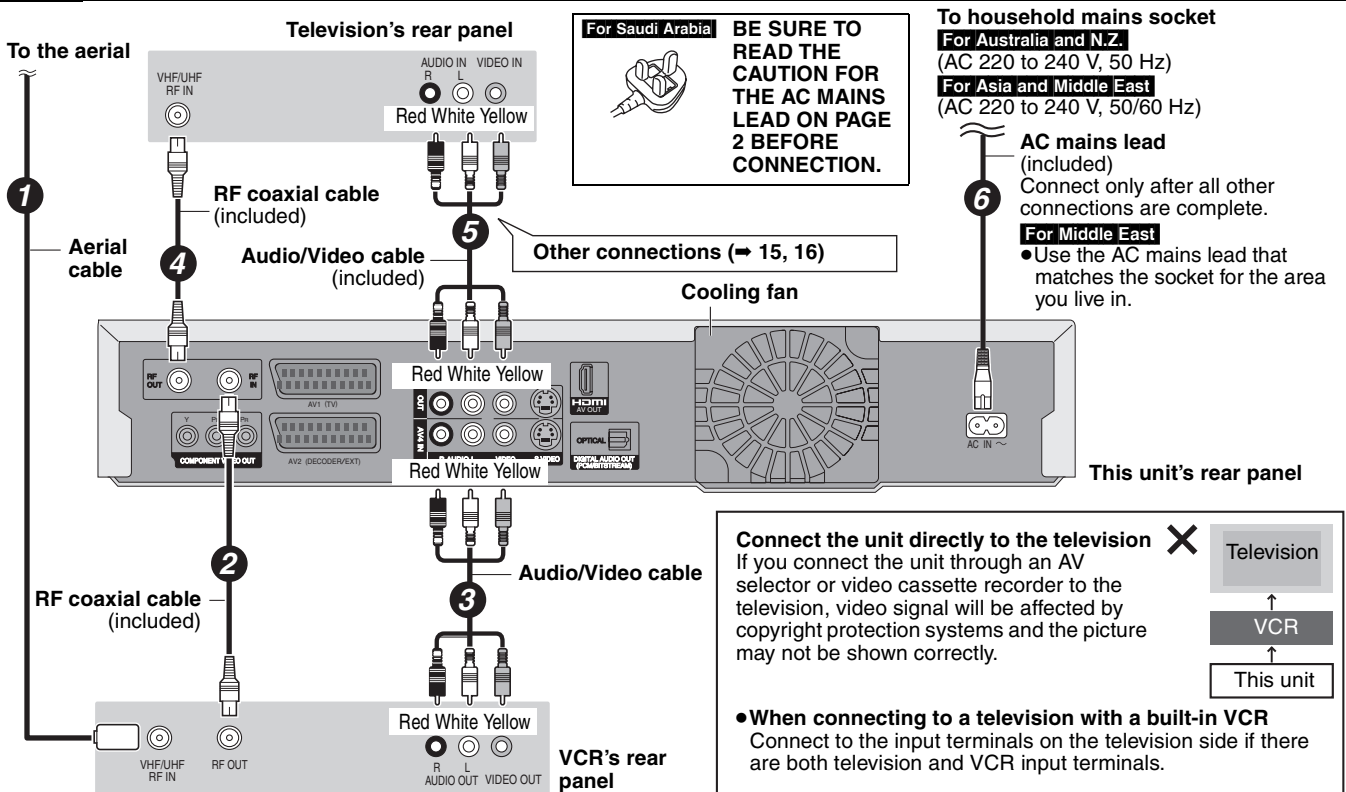

## Connecting to a television with 21-pin Scart terminal

You can also connect with the AV1 terminal on this unit using the 21-pin Scart cable. If your television is equipped with RGB input capability, by connecting with a fully wired 21-pin Scart cable you can see video using RGB output on this unit.

### Required setting

"AV1 Output" in the Setup menu (⇒ 61)

## Connecting to a VCR with 21-pin Scart terminal

You can also connect with the AV2 terminal on this unit using the 21-pin Scart cable.

### Required setting

"AV2 Input" in the Setup menu (⇒ 61)



## Other connections

### Connecting a television with S VIDEO terminals

The S VIDEO OUT terminal achieves a more vivid picture than the VIDEO OUT terminal. (Actual results depend on the television.)

#### Television's rear panel

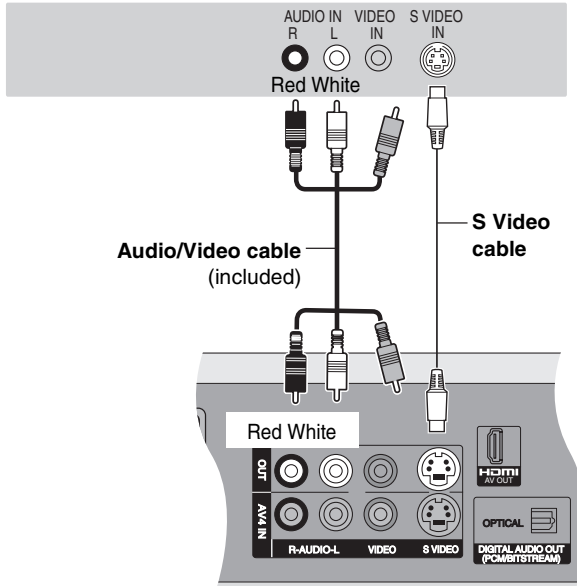

This unit's rear panel

### Connecting a television with COMPONENT VIDEO terminals

#### Television's rear panel

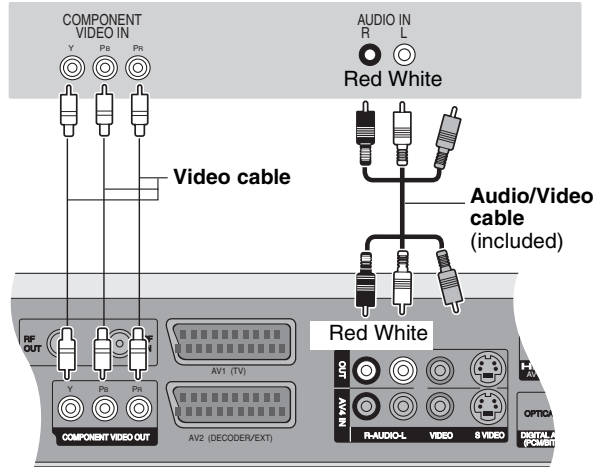

This unit's rear panel

COMPONENT VIDEO terminals can be used for either interlace or progressive output (⇒ 73) and provide a purer picture than the S VIDEO OUT terminal.

- Connect to terminals of the same colour.

#### If you have a regular television (CRT: cathode ray tube)

Use component output with progressive "Off" (Factory setting ⇒ 61), even if it is progressive compatible, because progressive output can cause some flickering. This is the same for multi system televisions using PAL mode.

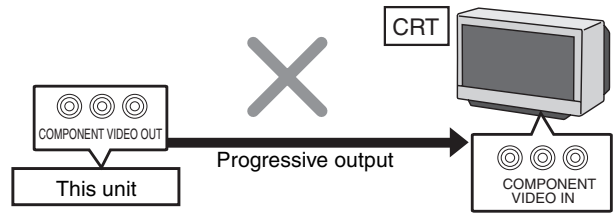

For progressive output (⇒ 18)

### Connecting an amplifier or system component

#### ■ Connecting an amplifier with a digital input terminal

- To enjoy multi-channel surround sound DVD-Video, connect an amplifier with Dolby Digital, DTS and MPEG decoders.

##### Required setting

- "Digital Audio Output" in the Setup menu (⇒ 60)
- When this unit is connected to an amplifier with an Optical digital audio cable and connected to a television with an HDMI cable, you can enjoy the highest quality of audio from the disc by setting "Digital Audio Output" to "Optical Only" in the Setup menu (⇒ 61). In this case audio is only output from the amplifier not the television.
- Before purchasing an optical digital audio cable (not included), check the terminal shape of the connected equipment.
- You cannot use DTS Digital Surround decoders not suited to DVD.
- Even if using this connection, output will be only 2 channels when playing DVD-Audio.

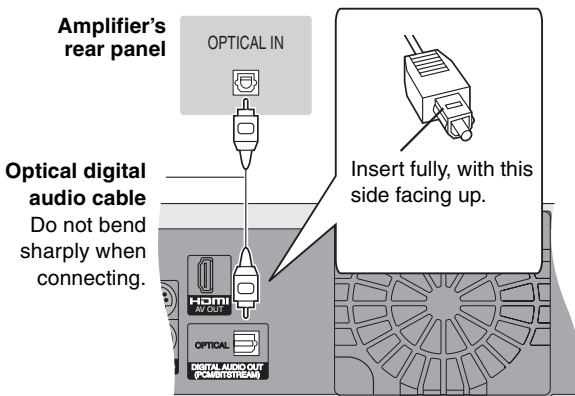

This unit's rear panel

#### ■ Connecting a stereo amplifier

##### Amplifier's rear panel

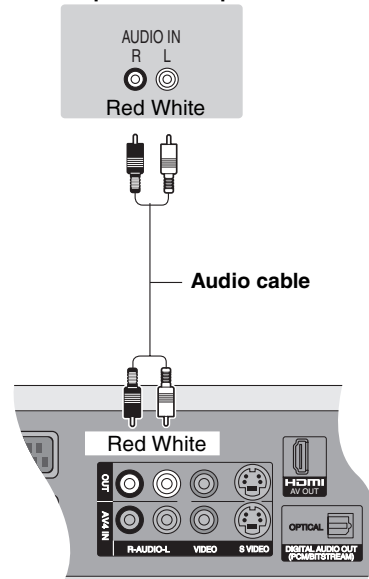

This unit's rear panel

## Connecting with an HDMI (High Definition Multimedia Interface) terminal

HDMI is the next-generation interface for digital devices. When connected to an HDMI compatible unit, an uncompressed digital audio and video signal is transmitted. You can enjoy high quality, digital video and audio with just one cord. When connecting to an HDMI-compatible HD TV (High Definition Television), the output can be switched to 1080i or 720p HD video.

● Please use HDMI cables that have the HDMI logo (as shown on the cover).

### Preparation

From the Setup menu (➔ 61), set “Digital Audio Output” to “HDMI and Optical”.

#### Connecting to a TV

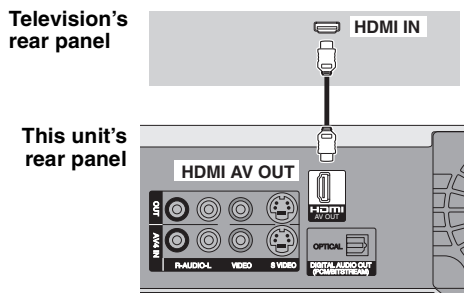

- If connecting to a TV incompatible with CPPM (Content Protection for Pre-recorded Media, ➔ 73), copy-protected DVD-Audio cannot be output through the HDMI terminal. Connect the audio cables (red and white) to the corresponding audio input terminals.
- If you are connecting to a TV that is only compatible with 2 channel output, audio with 3 channels or more will be down mixed (➔ 73) and output as 2 channels. (Some discs cannot be down mixed.)
- For units compatible with HDCP (High-Bandwidth Digital Content Protection) copyright protection that are equipped with a digital DVI input terminal (PC monitors, etc.): Depending on the unit, images may not display properly or at all when connecting with a DVI/HDMI switching cable. (Audio cannot be output.)

#### Connecting to an amplifier/receiver

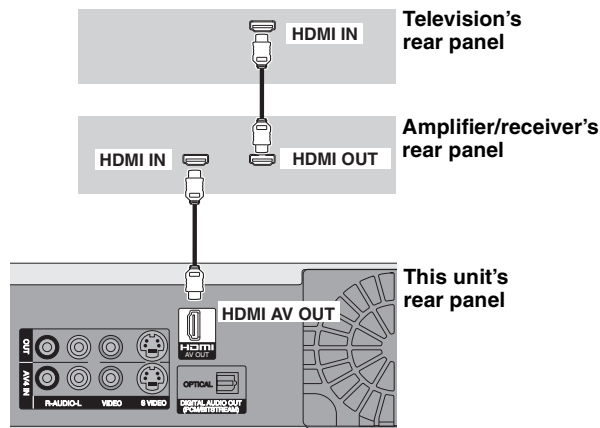

- If connecting to an amplifier/receiver incompatible with CPPM (Content Protection for Pre-recorded Media, ➔ 73), copy-protected DVD-Audio cannot be output through the HDMI terminal. Connect to the amplifier with an optical digital cable or audio cables (red and white).

## Control with HDMI (HDAVI Control™)

### What is HDAVI Control?

HDAVI Control is a convenient function that offers linked operations of this unit, and a Panasonic TV (VIERA) or receiver under HDAVI Control. You can use this function by connecting the equipment with the HDMI cable. See the operating instructions for connected equipment for operational details.

- It is recommended that you use Panasonic's HDMI cable.  
Recommended part number: RP-CDHG15 (1.5 m), RP-CDHG30 (3.0 m), RP-CDHG50 (5.0 m), etc.
- Non-HDMI-compliant cables cannot be utilized.

### Preparation

1. Connect this unit to your TV or receiver with an HDMI cable (➔ above).
2. Set “Control with HDMI” to “On” (➔ 61). (The default setting is “On”.)
3. Set the HDAVI Control operations on the connected equipment (e.g., TV).
4. Turn on all HDAVI Control compatible equipment, turn the TV off and on, and then select this unit's input channel on the connected TV so that the HDAVI Control function works properly.

Also when the connection or settings are changed, repeat this procedure.

### What you can do with HDAVI Control

(When the TV is on) <b>Easy playback</b>	When the TV is on and the following operations are performed, the TV will automatically switch the input channel and displays the corresponding action. (Picture or sound may not be available for the first few seconds.) <b>Press [FUNCTIONS]<sup>*1</sup>, [▶] (PLAY)<sup>*2</sup>, [DIRECT NAVIGATOR], [G-Code]<sup>*3</sup>, [PROG/CHECK].</b>
(When the TV is off) <b>Power on link</b>	When the TV is off and the following operations are performed, the TV will automatically turn on and displays the corresponding action. (Picture or sound may not be available for the first few seconds.) <b>Press [FUNCTIONS]<sup>*1</sup>, [▶] (PLAY)<sup>*2</sup>, [DIRECT NAVIGATOR], [G-Code]<sup>*3</sup>, [PROG/CHECK].</b> ● <b>DVD-V DVD-A CD VCD</b> and <b>MP3</b> The TV is automatically turned on when you insert the discs.
<b>Power off link</b>	When you turn the TV off, the unit is also automatically turned off. The unit automatically turns off even if the FUNCTIONS screen, the status message or the on-screen menu is displayed, during playback or when the unit is only timer recording. Even if the TV is turned off, the unit will not turn off at the same time in the following conditions: –when you pressed [● REC] and the unit is recording, –when copying –when finalizing –during Auto-Setup, Child Lock and Manual Tuning ● When this unit is connected to an HDAVI Control compatible Panasonic receiver with an HDMI cable, the receiver will also turn off.

\*1 This button is available only when this unit is on.

\*2 When this button is pressed, the playback image is not immediately displayed on the screen and it may not be possible to watch the contents from where playback started.

In this case, press [◀◀] or [◀◀] to go back to where playback started.

\*3 Only for Australia and N.Z.

### Note

- These functions may not work normally depending on the equipment condition.
- About HDAVI Control function, read the manual of the connected equipment (e.g., TV) too.

# STEP 2 Channel reception settings and TV aspect settings

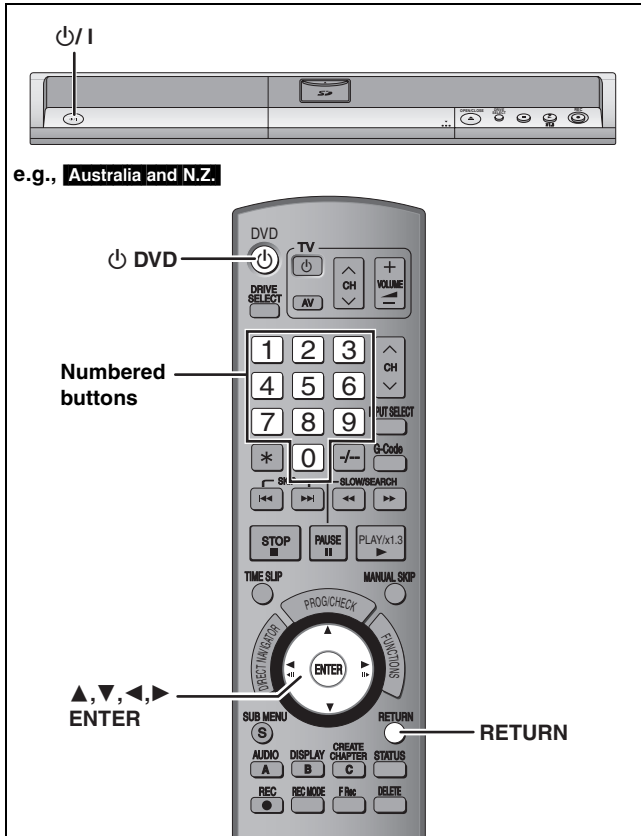

e.g., **Australia and N.Z.**

- 1 Turn on the television and select the appropriate AV input to suit the connections to this unit.
- 2 Press [**⏻ DVD**] to turn the unit on.

**For Australia and N.Z.**  
The country setting menu appears on the television.

Press [**▲, ▼**] to select the country and press [**ENTER**]. Pre-set channels are set when you select "Australia" in the country setting menu. Auto-Setup does not start. The clock setting menu appears (⇒ step 3). If your favourite channel is not received after selecting "Australia", perform "Restart set up" (⇒ 63).

Auto-Setup starts. This takes about 5 minutes.



Auto-Setup is complete when you see the clock setting menu.

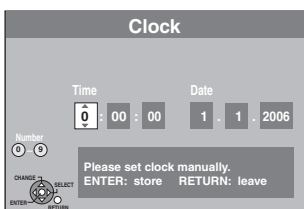

- 3 Press [**◀, ▶**] to select the item you want to change.

This is a 24-hour clock.

The items change as follows:

Hour ↔ Minute ↔ Second ↔ Day ↔ Month ↔ Year

Reset the clock regularly to maintain accuracy (⇒ 64). (Monthly accuracy +/- 15 seconds.)

- 4 Press [**▲, ▼**] to change the setting. You can also use the numbered buttons for setting.
- 5 Press [**ENTER**] when you have finished the settings.

TV aspect setting screen appears.

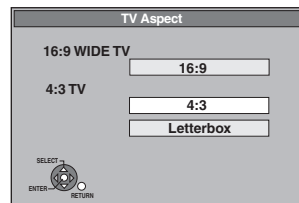

- 6 Press [**▲, ▼**] to select the TV aspect and press [**ENTER**].

• **16:9:** 16:9 widescreen television

• **4:3:** 4:3 aspect television

**HDD RAM** Titles are recorded as they appear on screen.

**DVD-V** Video recorded for a widescreen is played as Pan & Scan (unless prohibited by the producer of the disc) (⇒ 73).

• **Letterbox:** 4:3 aspect television

Widescreen picture is shown in the letterbox style (⇒ 73).

**To stop partway**

Press [**RETURN**].

■ To confirm that stations have been tuned correctly (⇒ 62)

■ To restart set up (⇒ 63)

# STEP 3 Set up to match your television and remote control

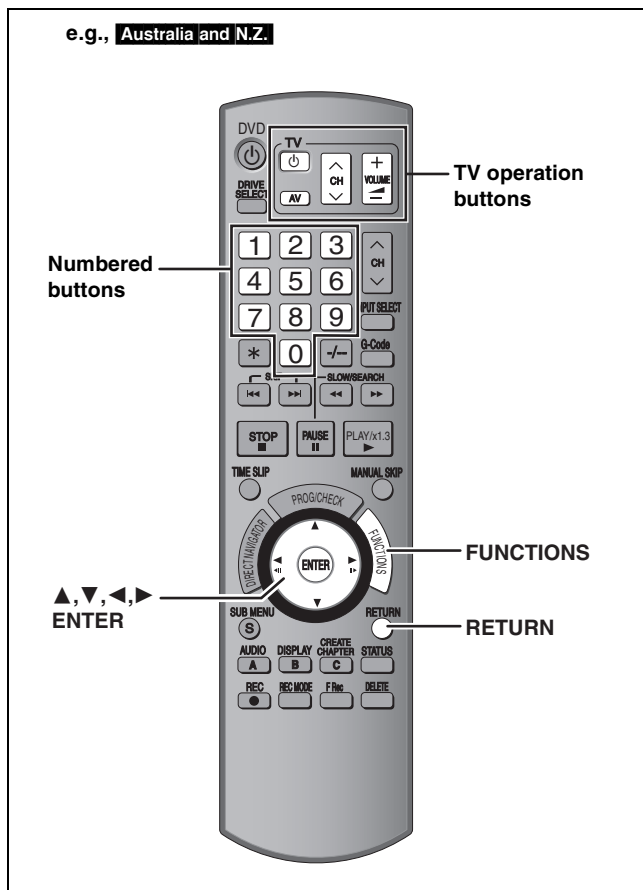

**4** Press [**▲**, **▼**] to select “Connection” and press [**▶**].

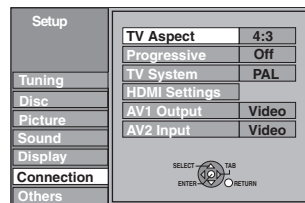

**5** Press [**▲**, **▼**] to select “Progressive” and press [**ENTER**].

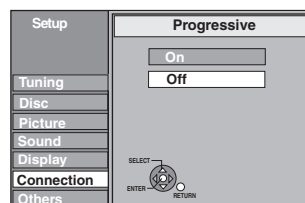

**6** Press [**▲**, **▼**] to select “On” and press [**ENTER**].

Output becomes progressive.

### Note

- When connected to a regular television (CRT: Cathode ray tube) or a multi system television using PAL mode, even if it is progressive compatible, progressive output can cause some flickering. Turn off “Progressive” if this occurs (⇒ 37).
- Picture will not be displayed correctly if connected to an incompatible television.
- There is no output from the COMPONENT VIDEO OUT terminals if “AV1 Output” in the Setup menu is set to “RGB 1 (without component)” or “RGB 2 (without component)” (⇒ 61).

## To enjoy progressive video

You can enjoy progressive video by connecting this unit’s COMPONENT VIDEO OUT terminals to an LCD/plasma television or LCD projector compatible with progressive scan (⇒ 73).

**1** While stopped  
Press [**FUNCTIONS**].

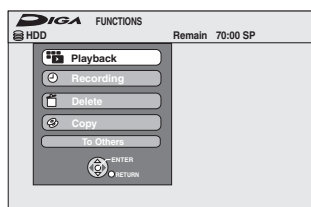

**2** Press [**▲**, **▼**] to select “To Others” and press [**ENTER**].

**3** Press [**▲**, **▼**] to select “Setup” and press [**ENTER**].

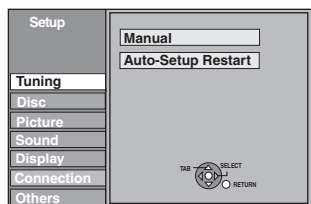

**To return to the previous screen**

Press [**RETURN**].

**To exit the screen**

Press [**RETURN**] several times.

## Television operation

You can configure the remote control TV operation buttons to turn the television on/off, change the television input mode, select the television channel and change the television volume.

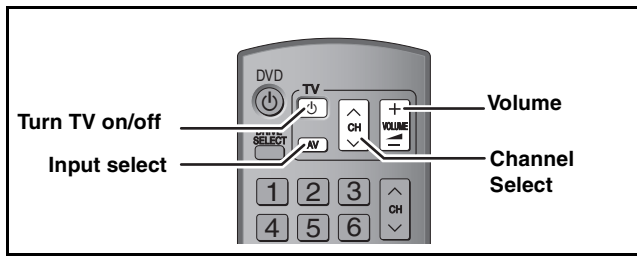

- 1 Point the remote control at the television  
While pressing [TV], enter the code with the numbered buttons.

e.g., 01: [0] → [1]    10: [1] → [0]

### Manufacturer and Code No.

Brand	Code
Panasonic/National	01, 02, 03, 04
GOLDSTAR/LG	15, 16
HITACHI	08
JVC	07
MITSUBISHI	09, 10
NEC	13
PHILIPS	12
SAMSUNG	12, 17, 18
SANYO	14, 19
SHARP	11
SONY	05
TOSHIBA	06

- 2 Test by turning on the television and changing channels.

- Repeat the procedure until you find the code that allows correct operation.
- If your television brand is not listed or if the code listed for your television does not allow control of your television, this remote control is not compatible with your television.

### Note

- If your television brand has more than one code listed, select the one that allows correct operation.

## When other Panasonic products respond to this remote control

Change the remote control code on the main unit and the remote control (the two must match) if you place other Panasonic products close together.

Use "DVD 1", the factory set code, under normal circumstances.

- 1 While stopped  
Press [FUNCTIONS].
- 2 Press [▲, ▼] to select "To Others" and press [ENTER].
- 3 Press [▲, ▼] to select "Setup" and press [ENTER].
- 4 Press [▲, ▼] to select "Others" and press [▶].
- 5 Press [▲, ▼] to select "Remote Control" and press [ENTER].
- 6 Press [▲, ▼] to select the code ("DVD 1", "DVD 2" or "DVD 3") and press [ENTER].

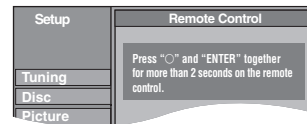

To change the code on the remote control

- 7 While pressing [ENTER], press and hold the numbered button ([1], [2] or [3]) for more than 2 seconds.
- 8 Press [ENTER].

- When the following indicator appears on the unit's display



The unit's remote control code

Change the code on the remote control to match the main unit's (→ step 7).

### Note

Executing "Shipping Condition" in the Setup menu returns the main unit code to "DVD 1". Change the remote control code to 1 (→ step 7).

### To return to the previous screen

Press [RETURN].

### To exit the screen

Press [RETURN] several times.

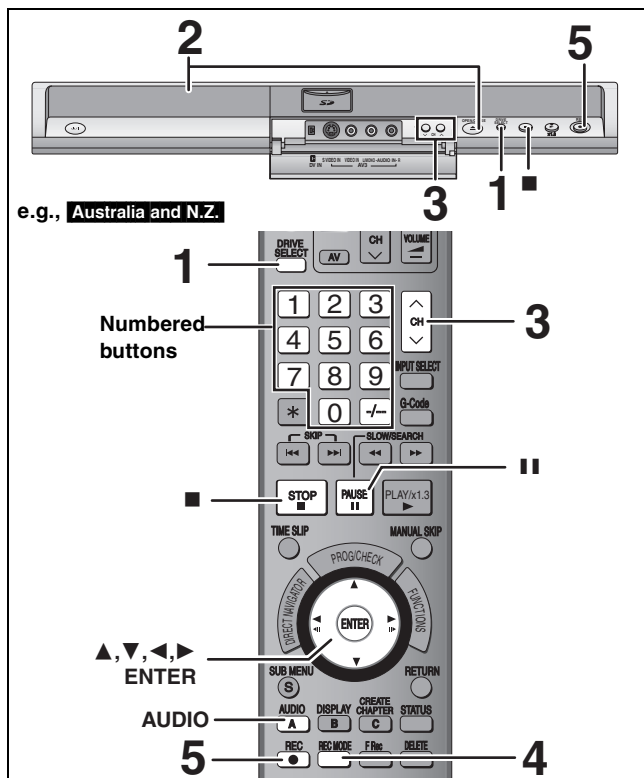

e.g., **Australia and N.Z.**

### See also "Important notes for recording" (⇒ 8).

Depending on the type of disc used for recording or the type of broadcast, there may be restrictions on the title you are trying to record.

- **RAM** It is not possible to record continuously from one side of a double sided disc to the other. You will need to eject the disc and turn it over.
- **+RW** You can create Top Menu using "Create Top Menu" (⇒ 55). Recording or editing on the disc may delete the menu. In that case, create the menu again.

#### HDD

- You can record up to 500 titles on HDD. (When continuously recording for long durations, titles are automatically divided every 8 hours.)

#### RAM -R -RW(V)

- You can record up to 99 titles on one disc.

#### +R +RW

- You can record up to 49 titles on one disc.

#### SD

- It is not possible to record onto a card.

#### Preparation

- Turn on the television and select the appropriate video input to suit the connections to this unit.
- Turn on this unit.

## 1 Press [DRIVE SELECT] to select the HDD or DVD drive.

The HDD or DVD indicator lights up on the unit's display.

## 2 If you selected the DVD drive

### Press [▲ OPEN/CLOSE] on the main unit to open the tray and insert a disc.

- Press the button again to close the tray.
- When using 8 cm DVD-RAM, or 8 cm DVD-R, remove the disc from the cartridge.

Insert label-up.

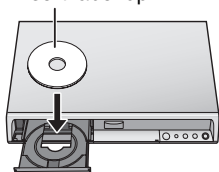

#### ■ Cartridge disc

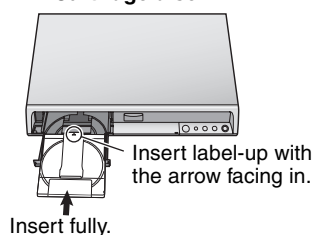

#### Automatic drive select function

**RAM** [Only for discs with the write-protect tab on the cartridge set to "PROTECT" (⇒ 53, Cartridge-protection)]

#### DVD-V DVD-A VCD CD

- If the unit is recording to the HDD or stopped, it automatically switches to the DVD drive when a disc is inserted.
- If you eject a disc and close the disc tray, the HDD drive is automatically selected.

## 3 Press [▲ ▼ CH] to select the channel.



To select with the numbered buttons:

e.g., 5: [5]

15: [-/-] ⇒ [1] ⇒ [5]

## 4 Press [REC MODE] to select the recording mode (XP, SP, LP or EP).



- To record sound using LPCM (XP mode only): Set the "Audio Mode for XP Recording" to "LPCM" in the Setup menu (⇒ 60).

## 5 Press [● REC] to start recording.



Recording will take place on open space on the HDD or on disc. Data will not be overwritten.

- You cannot change the channel or recording mode during recording. You can change the channel or recording mode while paused; however, the recording will then be as a separate title.
- You can record while the unit is in standby for timer recording, but once the time for the timer recording to begin is reached, any recording taking place will stop and the timer recording will begin.
- **HDD RAM** You can change the audio being received by pressing [AUDIO] during recording. (Does not affect the recording of audio.)

### ■ To pause recording

Press [||].

Press again to restart recording.

You can also press [● REC] to restart. (Title is not split into separate titles.)

### ■ To stop recording

Press [■].

● From the start to the end of the recording is called one title.

- **-R -RW(V) +R +RW** It takes about 30 seconds for the unit to complete recording management information after recording finishes.

In order to play DVD-R, DVD-RW (DVD-Video format) and +R (recorded with this unit) on other DVD players, it is necessary to finalize them (⇒ 55).

### Quick Start (⇒ 61)

#### 1 Sec. Quick Start for Recording on DVD-RAM and HDD

(When connecting to TV using 21-pin Scart, COMPONENT VIDEO, VIDEO or S VIDEO terminals)

From the power off state, recording on DVD-RAM and HDD starts about 1 second after first pressing the Power button and then sequentially pressing the REC button (Quick Start Mode).

"Quick Start" is set to "On" at the time of purchase.

#### Note

Startup takes up to a minute when:

- You play a disc or start recording to discs other than DVD-RAM.
- You want to make other operations.
- The clock has not been set.



## Recording modes and approximate recording times

Depending on the content being recorded, the recording times may become shorter than indicated.  
(The times provided on this chart are an estimate.)

Recording Mode	HDD (250 GB)	DVD-RAM		DVD-R DVD-RW +R +RW (4.7 GB)	DVD-R DL <sup>*3</sup> (8.5 GB)	+R DL <sup>*3</sup> (8.5 GB)
		Single-sided (4.7 GB)	Double-sided <sup>*1</sup> (9.4 GB)			
<b>XP (High picture quality recording mode)</b>	55 hours	1 hour	2 hours	1 hour	1 hour 45 min.	1 hour 45 min.
<b>SP (Standard recording mode)</b>	111 hours	2 hours	4 hours	2 hours	3 hours 35 min.	3 hours 35 min.
<b>LP (Long recording mode)</b>	222 hours	4 hours	8 hours	4 hours	7 hours 10 min.	7 hours 10 min.
<b>EP (Extra long recording mode)<sup>*4</sup></b>	443 hours (333 hours <sup>*2</sup> )	8 hours (6 hours <sup>*2</sup> )	16 hours (12 hours <sup>*2</sup> )	8 hours (6 hours <sup>*2</sup> )	14 hours 20 min. (10 hours 45 min. <sup>*2</sup> )	
<b>FR (Flexible Recording Mode)<sup>*4</sup></b>	443 hours maximum	8 hours maximum	8 hours maximum for one side	8 hours maximum	14 hours 20 min.	Approximately 9 hours with video quality equivalent to LP mode.

<sup>\*1</sup> It is not possible to record or play continuously from one side of a double sided disc to the other.

<sup>\*2</sup> When "Recording time in EP mode" is set to "EP (6 Hours)" in the Setup menu (⇒ 59).

The sound quality is better when using "EP (6 Hours)" than when using "EP (8 Hours)".

<sup>\*3</sup> You cannot record directly to DVD-R DL and +R DL discs with this unit. The table shows the recording time when copying.

**+R DL** You cannot copy in EP mode.

<sup>\*4</sup> When recording to the HDD in "EP" or "FR (recordings 5 hours or longer)" mode, you cannot perform high-speed copy to +R, +R DL or +RW discs.

● **RAM** When recording to DVD-RAM using "EP (8 Hours)" mode, play may not be possible on DVD players that are compatible with DVD-RAM. Use "EP (6 Hours)" mode if playback may be on other equipment.

### FR (Flexible Recording Mode)

You can set FR (Flexible Recording) mode when copying or programming timer recordings.

The unit automatically selects a recording rate between XP and EP (8 Hours) that will enable the recordings to fit in the remaining disc space with the best possible recording quality.

For example with a 90 minute recording to an unused DVD-RAM, the picture quality is adjusted to between "XP" and "SP".

● When recording to the HDD, picture quality is automatically adjusted to precisely fit a copied title on a 4.7 GB disc.

● All the recording modes from XP to EP appear in the display.



## Disc Insertion/Ejection

### When the format confirmation screen is displayed

**RAM -RW(V) +R +R DL +RW**

When you insert a new disc or a disc recorded on a computer or other equipment, a format confirmation screen is displayed. Format the disc to use it. However, all the recorded contents are deleted.

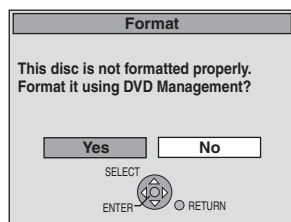

Press [◀, ▶] to select "Yes" and press [ENTER].

### To format a disc

"Deleting all the contents of a disc or card—Format" (⇒ 54)

### When removing a recorded disc

**+R -R DL -RW(V) +R +R DL**

The following screen appears when you have not processed the disc for play on other equipment.

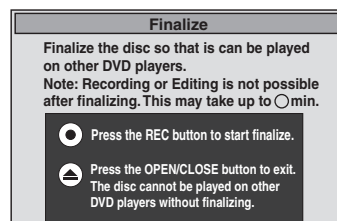

### ■ To finalize the disc

Press [● REC] on the main unit.

● You cannot stop this process once you have started it.

● If you want to set the background, play menu select or provide a disc name, select "Top Menu (⇒ 55)", "Auto-Play Select (⇒ 55)" or "Disc Name (⇒ 53)" in "DVD Management" before finalizing.

### ■ To open the tray without disc finalization

Press [▲ OPEN/CLOSE] on the main unit.

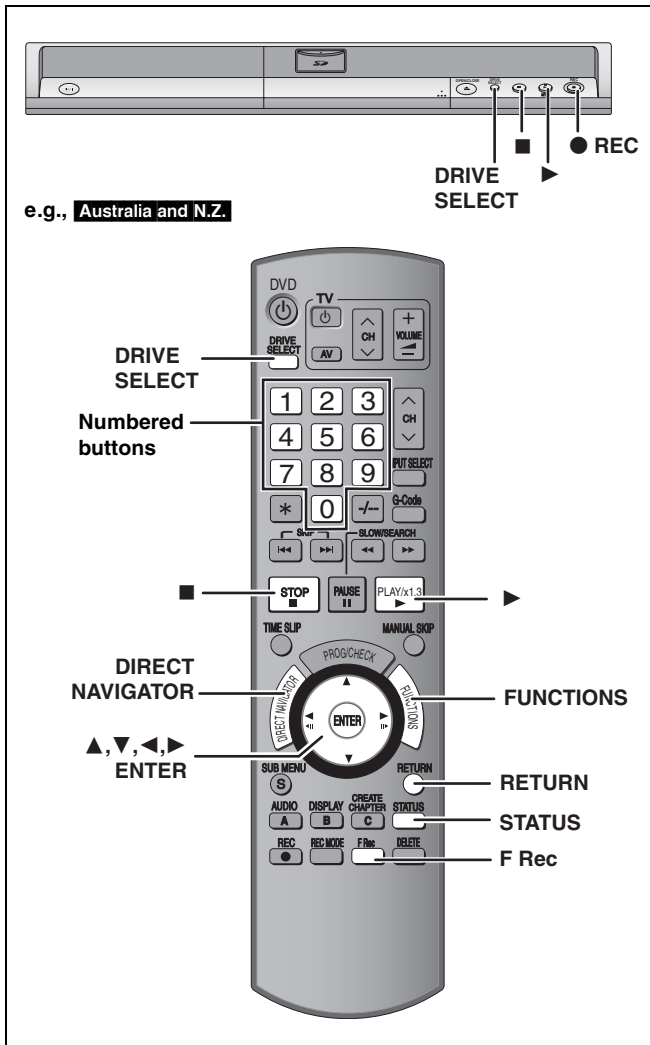

e.g., **Australia and N.Z.**

## Recording settings for High Speed Copy

**When copying in high speed mode to DVD-R, DVD-R DL, DVD-RW (DVD-Video format), +R, +R DL and +RW after you have recorded to the HDD**

If copying a title using the high speed mode to a DVD-R, etc., set "Rec for High Speed Copy" to "On" before recording to the HDD. **However, the following restrictions apply:**

- When recording bilingual broadcasts, either the main or secondary audio can be recorded.
  - If you do not connect external equipment  
Select "M 1" or "M 2" in "Bilingual Audio Selection" in the Setup menu (⇒ 60).
  - If you connect external equipment  
Select "M 1" or "M 2" on the external equipment.
- Even 16:9 aspect (Widescreen) programmes are recorded in 4:3 aspect.

Refer to the "Important notes for recording" for more information (⇒ 8).

- 1 While stopped  
Press [FUNCTIONS].
- 2 Press [▲, ▼] to select "To Others" and press [ENTER].
- 3 Press [▲, ▼] to select "Setup" and press [ENTER].
- 4 Press [▲, ▼] to select "Disc" and press [▶].
- 5 Press [▲, ▼] to select "Settings for Recording" and press [ENTER].
- 6 Press [▲, ▼] to select "Rec for High Speed Copy" and press [ENTER].
- 7 Press [▲, ▼] to select "On" and press [ENTER].
- 8 Press [◀, ▶] to select "Yes" and press [ENTER].

## To specify a time to stop recording—One Touch Recording

**HDD | RAM | -R | -RW(V) | +R | +RW**

During recording  
Press [● REC] on the main unit to select the recording time.

- You can specify up to 4 hours later.
- The unit display changes as shown below.  
OFF 0:30 → OFF 1:00 → OFF 1:30 → OFF 2:00  
↑ Counter (cancel) ← OFF 4:00 ← OFF 3:00 ↓
- This does not work during timer recordings (⇒ 24) or while using Flexible Recording (⇒ 23).
- If you change the channel or recording mode while recording is paused, the time specified to stop recording is cancelled.
- The unit turns off automatically after the time to stop recording is reached.

### To cancel

Press [● REC] on the main unit several times until the counter appears.

- The time to stop recording is cancelled; however, recording continues.

### To stop recording

Press [■].

**To return to the previous screen**  
Press [RETURN].

**To exit the screen**  
Press [RETURN] several times.

**To start recording**

- Recording television programmes (⇒ 20)
- Timer recording (⇒ 24)
- Copying from a video cassette recorder (⇒ 52)

**Note**  
If you do not intend to copy titles in high speed mode to DVD-R, DVD-R DL, DVD-RW (DVD-Video format), +R, +R DL and +RW, set "Rec for High Speed Copy" to "Off".

## Flexible Recording

(Recording that fits the remaining disc space)

**HDD RAM -R -RW(V) +R +RW**

The unit sets the best possible picture quality that fits the recording within the remaining disc space. The recording mode becomes FR mode.

### Using “Flexible Rec” is convenient in these kinds of situations.

**RAM -R -RW(V) +R +RW**

- When the amount of free space on the disc makes selecting an appropriate recording mode difficult
- When you want to record a long programme with the best picture quality possible

**HDD**

- When you want to record a title to HDD so that it can then be copied to fit one 4.7 GB disc perfectly
- You do not need to edit the recorded title, or change the recording mode when copying, to fit the disc space

e.g., Recording a 90 minute programme to disc

#### If you select XP mode, the programme will not fit one disc.

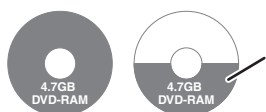

If you try to record a 90 minute programme in XP mode, only the first 60 minutes will fit on the disc and the 30 minute balance will not get recorded.

- Another disc is necessary.

#### If you select SP mode, the programme will fit one disc.



However there will be 30 minutes remaining disc space.

#### If you select “Flexible Rec” the programme will fit one disc perfectly.



■ Necessary space for recording

### Preparation

- Select the channel or the external input to record.
- Press [DRIVE SELECT] to select the HDD or DVD drive.

## 1 While stopped Press [F Rec].

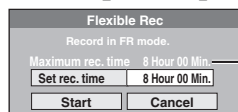

**Maximum recording time**  
This is the maximum recording time in EP (8 Hours) mode.

## 2 Press [◀, ▶] to select “Hour” and “Min.” and press [▲, ▼] to set the recording time.

- You can also set the recording time with the numbered buttons.
- You cannot record more than 8 hours.

## 3 When you want to start recording Press [▲, ▼, ▶, ▶] to select “Start” and press [ENTER].

- Recording starts.
- All the recording modes from XP to EP appear in the display.



### To exit the screen without recording

Press [RETURN].

### To stop recording partway

Press [■].

### To show the remaining time

Press [STATUS].

e.g., HDD

Remaining time of recording

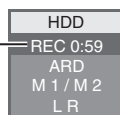

## Playing while you are recording

**HDD RAM**

### Playing from the beginning of the title you are recording—Chasing playback

#### Press [▶] (PLAY) during recording.

There is no sound output while searching forward or backward.

#### To stop play

Press [■].

#### To stop recording

2 seconds after play stops, press [■].

#### To stop timer recording

2 seconds after play stops

- 1 Press [■].
- 2 Press [◀, ▶] to select “Stop Recording” and press [ENTER].

### Playing a title previously recorded while recording—Simultaneous rec and play

- You can also change the drive and play while recording. Press [DRIVE SELECT].

## 1 Press [DIRECT NAVIGATOR] during recording.

## 2 Press [▲, ▼, ▶, ▶] to select a title and press [ENTER].

- There is no sound output while searching forward or backward.

#### To stop play

Press [■].

#### To exit the Direct Navigator screen

Press [DIRECT NAVIGATOR].

#### To stop recording

After play stops

- 1 Press [DIRECT NAVIGATOR] to exit screen.
- 2 If the recording is on the other drive  
Press [DRIVE SELECT] to select the recording drive.
- 3 Press [■].

#### To stop timer recording

After play stops

- 1 Press [DIRECT NAVIGATOR] to exit screen.
- 2 If the recording is on the other drive  
Press [DRIVE SELECT] to select the recording drive.
- 3 Press [■].
- 4 Press [◀, ▶] to select “Stop Recording” and press [ENTER].

### Note

“Chasing playback” and “Simultaneous rec and play” can only be used with programmes of the same encoding system (PAL/NTSC).

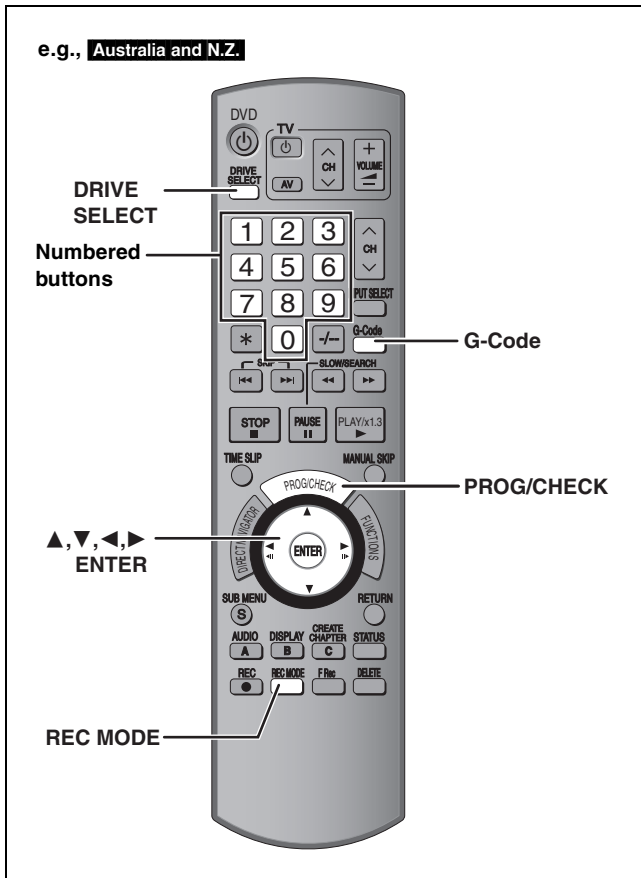

**See also “Important notes for recording” (⇒ 8).**

Depending on the type of disc used for recording or the type of broadcast, there may be restrictions on the title you are trying to record.

**HDD RAM -R -RW(V) +R +RW**

- You can enter up to 32 programmes up to a month in advance. (Each daily or weekly programme is counted as one programme.)

**Preparation**

- Turn on the television and select the appropriate video input to suit the connections to this unit.
- If recording to DVD, insert a disc that you can use for recording (⇒ 20).
- Make sure that the clock settings are correct (⇒ 64).

**For Australia and N.Z.**

**G-CODE**®  
 G-CODE is a registered trademark of Gemstar Development Corporation. The G-CODE system is manufactured under license from Gemstar Development Corporation.

**For Australia and N.Z.**

## Using G-CODE system to make timer recordings

Entering G-CODE numbers is an easy way of timer recording. You can find these numbers in TV listings in newspapers and magazines.

**1 Press [G-Code].**

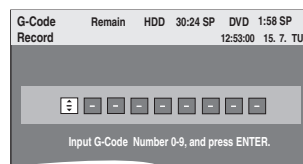

**2 Press the numbered buttons to enter the G-CODE number.**

Press [◀] to move back to correct a digit.

**3 Press [ENTER].**

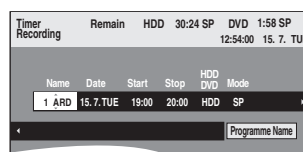

- Confirm the programme and make corrections if necessary using [▲, ▼, ◀, ▶] (⇒ 25, step 3).
- When “-- --” appears in the “Name” column, you cannot set timer recording. Press [▲, ▼] to select desired programme position. After you have entered the information of a TV station, it is kept in the unit’s memory.

**4 Press [ENTER].**

The settings are stored and the timer programme is on. Timer icon is displayed in left column.

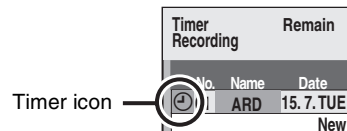

“⌚” lights on the unit’s display to indicate timer recording standby has been activated.

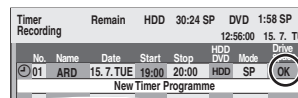

Check to make sure “OK” is displayed (⇒ 27).

Repeat steps 1–4 to programme other recordings.

- To cancel recording when recording has already begun (⇒ 26)
- To release the unit from recording standby (⇒ 26)
- Notes on timer recording (⇒ 26)

# Manually programming timer recordings

## 1 Press [PROG/CHECK].

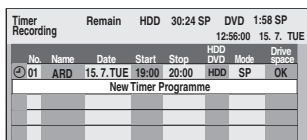

## 2 Press [▲, ▼] to select “New Timer Programme” and press [ENTER].

## 3 Press [▶] to move through the items and change the items with [▲, ▼].

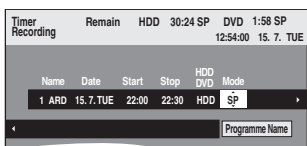

- Press and hold [▲, ▼] to alter the Start (Start time) and Stop (Finish time) in 30-minute increments.
- You can also set Name (Programme position/TV Station Name), Date, Start (Start time), and Stop (Finish time) with the numbered buttons.

### •Date

- Date: Current date up to one month later minus one day
- ↓ ↑
- Daily timer: SUN-SAT → MON-SAT → MON-FRI
- ↓ ↑
- Weekly timer: SUN → --- → SAT

- You can also press [DRIVE SELECT] to select the recording drive.

When the recording drive is “DVD” and there is not enough remaining space, recording automatically switches to the “HDD” (⇒ 27, Relief Recording).

- You can also press [REC MODE] to change the recording mode.

- **HDD RENEW (Auto Renewal Recording)** (⇒ 27)  
ON ↔ OFF

### •Programme Name

Press [◀, ▶] to select “Programme Name” and press [ENTER]. (⇒ 56, Entering text)

## 4 Press [ENTER].

The settings are stored and the timer programme is on. Timer icon is displayed in left column.

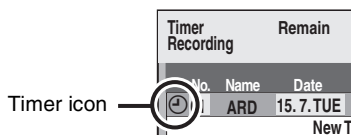

“⌚” lights on the unit’s display to indicate timer recording standby has been activated.



Check to make sure “OK” is displayed (⇒ 27).

Repeat steps 2–4 to programme other recordings.

- To cancel recording when recording has already begun (⇒ 26)
- To release the unit from recording standby (⇒ 26)
- Notes on timer recording (⇒ 26)

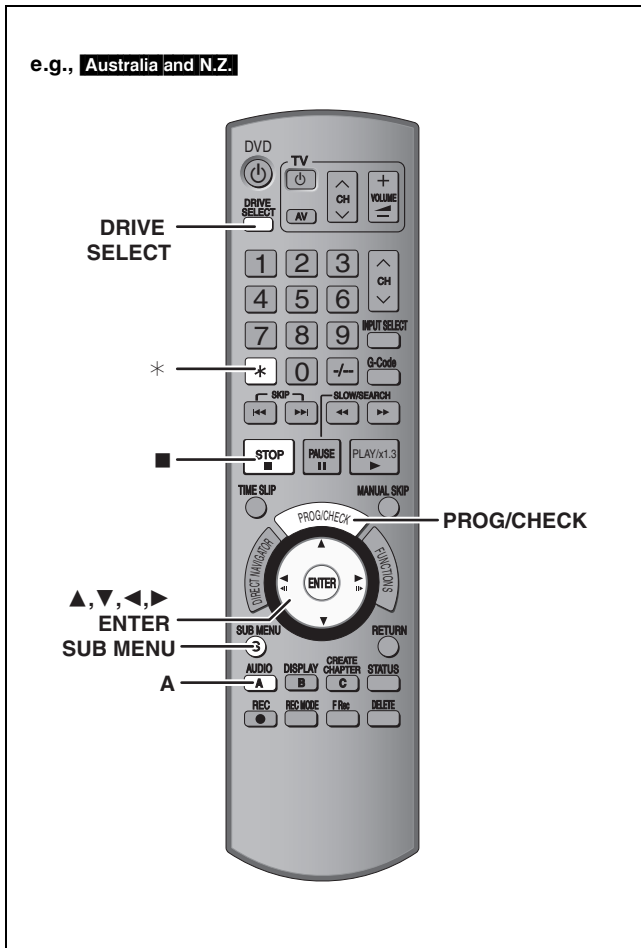

## To cancel recording when recording has already begun

- 1 While the unit is on  
Press **[DRIVE SELECT]** to select the recording drive and press **[■]**.



- 2 Press **[◀, ▶]** to select “Stop Recording” and press **[ENTER]**.

If you stop a timer recording, it will be cancelled. However, if you have set a weekly or daily timer recording, the recording will start from the next time the timer recording is set.

## To release the unit from recording standby

- Even when the unit is turned off, you can display the timer recording list by pressing **[PROG/CHECK]**.

- 1 Press **[PROG/CHECK]**.
- 2 Press **[▲, ▼]** to select the programme and press **[A]**.

- The timer icon “Ⓢ” (⇒ 27, left column) disappears from the timer recording list.
- You cannot cancel timer recording standby mode as long as even one timer icon “Ⓢ” (⇒ 27, left column) remains in the timer recording list.
- Press **[A]** again to activate timer recording standby.

## Notes on timer recording

- “Ⓢ” flashes on the unit’s display for about 5 seconds when the unit cannot go to timer recording standby.
- Timer recordings are activated regardless of whether the unit is turned on/off.
- Timer recordings begin when the set time is reached even when playing.
- Timer recordings do not begin while editing or copying in normal speed mode (⇒ 45).
- If the unit is turned on when timer recording begins, it remains turned on after recording finishes. It does not turn off automatically. You can turn the unit off during timer recording.
- If the unit is not put in the timer recording standby mode at the last 10 minutes before the programmed timer recording starting time, the “Ⓢ” flashes on the unit’s display.
- When you programme successive timer recordings to start immediately one after the other, the unit cannot record the part at the beginning of the later programmes.

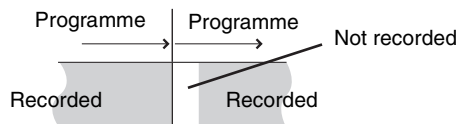

- If the actual broadcasting times of timer recordings overlap, the recording that starts first always has priority, and the recording of the later programme will start only after the first timer recording has finished.



## Check, change or delete a programme

- Even when the unit is turned off, you can display the timer recording list by pressing [PROG/CHECK].

### Press [PROG/CHECK].

#### Icons

- ⊙ Timer recording standby is activated.
  - This programme is currently recording.
  - Ⓜ The times overlap those in another programme. Recording of the programme with the later start time starts when the earlier programme finishes recording.
  - ⊖ You stopped a weekly or daily timer recording. The icon disappears the next time the timer programme starts recording.
  - ⓕ The disc was full so the programme failed to record.
  - Ⓢ The material was copy-protected so it was not recorded.
  - ⓧ The programme did not complete recording because the disc is dirty or some other reason.
  - ⓐ Timer programmes set to Auto Renewal Recording (→ right column).
  - ↗ Titles that have been rerouted to the HDD (Displayed while recording.)
- HDD** Recording drive is set to HDD  
**DVD** Recording drive is set to DVD

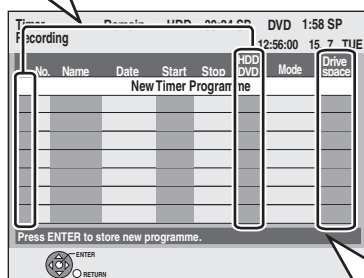

#### Message displayed in the "Drive space" line

- OK:** Displayed if the recording can fit in the remaining space.
- **(Date):** For recordings made daily or weekly, the display will show until when recordings can be made (up to a maximum of one month from the present time) based on the time remaining on the disc.
- ! :** It may not be possible to record because:
  - there is not enough space left
  - the number of possible titles has reached its maximum.
- Relief:** Timer programmes that will be relief recorded to the HDD.

### ■ To change a programme

Press [▲, ▼] to select the programme and press [ENTER].  
 (→ 25, step 3)

### ■ To delete a programme

Press [▲, ▼] to select the programme and press [\*].

You can also delete a programme with the following steps

- 1 Press [▲, ▼] to select the programme and press [SUB MENU].
- 2 Press [▲, ▼] to select "Delete" and press [ENTER].

### ■ To exit the timer recording list

Press [PROG/CHECK].

Programmes that failed to record are deleted from the timer recording list at 4 a.m. two days later.

## Relief Recording

When the recording drive is "DVD" and there is not enough remaining space, recording automatically switches to the "HDD". If there is no disc in the tray or the disc cannot be recorded on or when timer recording starts while copying, the recording drive will be altered to the HDD.

- The Direct Navigator shows which programmes were relief-recorded ("↗" is displayed.) (→ 28).
- If the time remaining on the HDD is insufficient, as much of the programme as possible will be recorded onto the HDD.

## Auto Renewal Recording

#### HDD

If you record a programme onto HDD repeatedly everyday or every week using timer recording, the unit will record the new programme over the old one.

**This function can be used only when weekly recording or daily recording is selected.**

- 1 Press [PROG/CHECK].
- 2 Press [▲, ▼] to select the programme and press [ENTER].
- 3 Press [◀, ▶] to select "RENEW" column.
- 4 Press [▲, ▼] to select "ON" and press [ENTER].

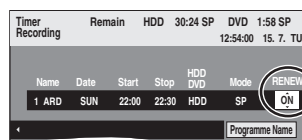

#### Note

- If a programme set for Auto Renewal Recording is protected or while play back is taking place from the HDD, or while copying, the programme will not be overwritten. Instead the programme set for recording will be saved as a separate programme, and this programme will be the one to be overwritten when the next Auto Renewal Recording takes place.
- Playlists made from programmes that were set for Auto Renewal Recording are deleted along with auto renewal.
- When there is not enough space on the HDD, the programme may not be recorded completely.

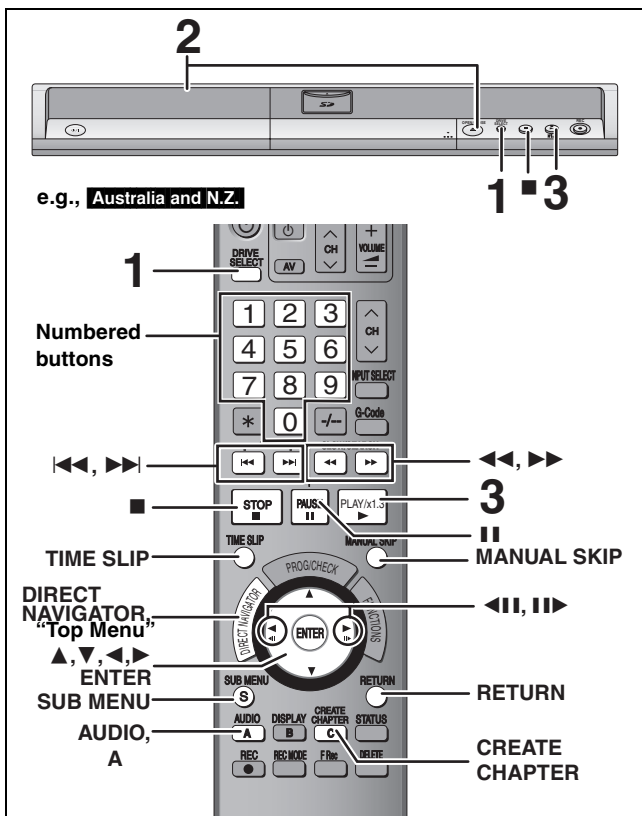

e.g., **Australia and N.Z.**

**16:9 aspect programmes are recorded in 4:3 aspect in the following cases.**  
 –If you recorded to the HDD or a DVD-RAM and “Rec for High Speed Copy” was set to “On” in the Setup menu (⇒ 59).  
 –If you recorded or copied to a DVD-R, DVD-R DL, DVD-RW (DVD-Video format), +R, +R DL or +RW.  
 It may be possible to adjust the display mode on the TV. Refer to your television’s operating instructions.

**Preparation**

- Turn on the television and select the appropriate video input to suit the connections to this unit.
- Turn on this unit.

**1 Press [DRIVE SELECT] to select the HDD or DVD drive.**

The HDD or DVD indicator lights up on the unit’s display.  
 • It is possible to watch playback from one drive while recording on another (editing is not possible).

**2 If you selected the DVD drive Press [▲ OPEN/CLOSE] on the main unit to open the tray and insert a disc.**

- Press the button again to close the tray.
- When using 8 cm DVD-RAM, or 8 cm DVD-R, remove the disc from the cartridge.

Insert label-up.

■ **Cartridge disc**

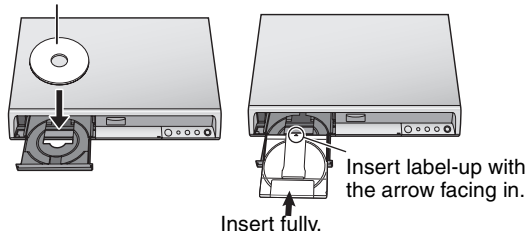

Insert fully.

Automatic drive select function (⇒ 20)

**3 Press [▶] (PLAY).**

**HDD RAM -R -R DL -RW(V) +R +R DL +RW -RW(VR)**

Play starts from the most recently recorded title.

**DVD-V DVD-A CD VCD** and MP3

Play starts from the beginning of the disc.

**DivX**

DivX Menu screen appears (⇒ 32)

- When using cartridge discs with the write-protect tab in the protect position (⇒ 53), play automatically starts when inserted in the unit.

**Selecting recorded programmes (titles) to play—Direct Navigator**

**HDD RAM -R -R DL -RW(V) +R +R DL +RW -RW(VR)**

**1 Press [DIRECT NAVIGATOR].**

• **Thumbnail Display**

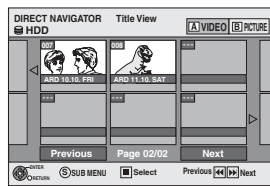

• **Table Display**

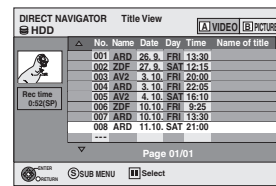

**Switching the Direct Navigator appearance**

- 1 Press [SUB MENU] while Thumbnail Display is displayed.
  - 2 Press [▲, ▼] to select “Table Display” and press [ENTER].
- The display appearance last used is saved even after the unit is turned off.

**2 [HDD RAM] Press [A] to select “VIDEO”.**



**[HDD] To sort Title View for easy searching (Table Display only)**

This function is convenient when searching for one title to playback from many titles.

- 1 Press [SUB MENU].
  - 2 Press [▲, ▼] to select “Sort” and press [ENTER].
  - 3 Press [▲, ▼] to select the item and press [ENTER].
- If you select an item other than “No.”

- The Direct Navigator screen will reappear after playback of the selected title has finished. (You cannot play titles continuously.)
- Skip and Time Slip will only function with the title currently being played back.
- If you exit the Direct Navigator screen, or switch to “PICTURE” Direct Navigator screen, the sorted Title View will be cancelled.

**3 Press [▲, ▼, ◀, ▶] to select the title and press [ENTER].**

You can also select titles with the numbered buttons.

e.g., **HDD RAM -R -R DL -RW(V) +R +R DL +RW -RW(VR)**

5: [0] ⇒ [0] ⇒ [5]      5: [0] ⇒ [5]  
 15: [0] ⇒ [1] ⇒ [5]      15: [1] ⇒ [5]  
 115: [1] ⇒ [1] ⇒ [5]

**To show other pages**

- Press [▲, ▼, ◀, ▶] to select “Previous” or “Next” and press [ENTER]. (Thumbnail Display only)
- You can also press [◀◀, ▶▶] to show other pages.

**To exit the screen**

Press [DIRECT NAVIGATOR].

**Direct Navigator screen icons**

- Currently recording.
- 🔒 Title protected.
- 📄 Title that was not recorded due to recording protection (Digital broadcasts etc.)
- ✗ Title cannot be played [When copying a title to the HDD, or when data is damaged etc.]
- ➡ Titles that have been rerouted to the HDD (⇒ 27, Relief Recording)
- 📄 Title with “One time only recording” restriction (⇒ 73, CPRM)
- NTSC (NTSC) Title recorded using a different encoding system from that of the TV system currently selected on the unit.
- PAL (PAL) • Alter the “TV System” setting on this unit to suit (⇒ 63).

## ■ When a menu screen appears on the television

### DVD-V DVD-A

Press [▲, ▼, ◀, ▶] to select the item and press [ENTER].

Some items can also be selected using the numbered buttons.

### VCD

Press the numbered buttons to select the item.

e.g., 5: [0] ⇒ [5] 15: [1] ⇒ [5]

### ● To return to the menu screen

**DVD-V** Press [DIRECT NAVIGATOR] or [SUB MENU].

**DVD-A** Press [DIRECT NAVIGATOR].

**VCD** Press [RETURN].

### Note

- It is not possible to play continuously from one side of a double sided disc to the other. You will need to eject the disc and turn it over.
- Depending on the disc, it may take time for the menu screen, pictures, sound, etc. to start.
- Discs continue to rotate while menus are displayed. Press [■] when you have finished playback to protect the unit's motor, your television screen and so on.
- The producer of the disc can control how discs are played. So you may not always be able to control play as described in these operating instructions. Read the disc's instructions carefully.
- When playing back a title recorded on the HDD, ensure that you match the "TV System" setting to the recorded title (⇒ 63).

## Operations during play

Stop	<p><b>Press [■].</b> The stopped position is memorized.</p> <p><b>Resume play function</b> Press [▶] (PLAY) to restart from this position.</p> <p><b>Stopped position</b></p> <ul style="list-style-type: none"> <li>● If [■] is pressed several times, the position is cleared.</li> <li>● The position is cleared if the tray is opened.</li> <li>● <b>DVD-A CD VCD</b> and <b>MP3/DivX</b> : The position is cleared if the unit is turned off.</li> </ul>
Pause	<p><b>Press [⏸].</b> Press [⏸] again or [▶] (PLAY) to restart play.</p>
Search	<p><b>Press [◀◀] or [▶▶].</b></p> <ul style="list-style-type: none"> <li>● The speed increases up to 5 steps. (+R +R DL +RW up to 3 steps)</li> <li>● Press [▶] (PLAY) to restart play.</li> <li>● Audio is heard during first level search forward.</li> <li>● <b>DVD-A</b> (excluding motion picture parts) <b>CD</b> and <b>MP3</b> : Audio is heard during all levels of search.</li> <li>● <b>DivX</b> : Audio is not heard during all levels of search.</li> <li>● Depending on the disc, Search may not be possible.</li> </ul>
Skip	<p><b>During play or while paused, press [◀◀] or [▶▶].</b></p> <p>Skip to the title, chapter or track you want to play.</p> <ul style="list-style-type: none"> <li>● Each press increases the number of skips.</li> <li>● <b>DivX</b> : Backward direction [◀◀] only.</li> </ul>
Starting from a selected title	<p><b>Press the numbered buttons.</b> Play starts from the selected title, chapter or track.</p> <ul style="list-style-type: none"> <li>● <b>HDD</b> e.g., 5: [0] ⇒ [0] ⇒ [5] 15: [0] ⇒ [1] ⇒ [5]</li> <li>● <b>MP3 and JPEG/TIFF</b> e.g., 5: [0] ⇒ [0] ⇒ [0] ⇒ [5] 15: [0] ⇒ [0] ⇒ [1] ⇒ [5]</li> <li>● <b>DVD-A</b> Selecting groups While stopped (screen saver is displayed on the television ⇒ right) Input a 1-digit number e.g., 5: [5]</li> <li>● Other discs (You can select a track with DVD-Audio.) Input a 2-digit number e.g., 5: [0] ⇒ [5] 15: [1] ⇒ [5]</li> <li>● This works only when stopped (screen saver is displayed on the television ⇒ above) with some discs.</li> <li>● <b>VCD</b> (with playback control) If you press the numbered buttons while stopped (the above screen saver is displayed on the television) you can cancel PBC. (Elapsed play time appears on the unit's display.)</li> </ul>
Quick View <b>HDD RAM</b>	<p><b>Press and hold [▶] (PLAY/×1.3).</b> Play speed is quicker than normal.</p> <ul style="list-style-type: none"> <li>● Press again to return to normal speed.</li> </ul>



Refer to the control reference on page 28.

## Operations during play

(continued)

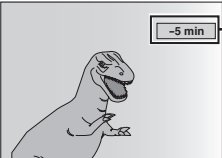
<p><b>Slow-motion</b></p> <p>HDD RAM -R -R DL -RW(V) +R +R DL +RW DVD-V DVD-A (Motion picture parts only) -RW(VR) VCD</p>	<p><b>While paused, press [◀◀] or [▶▶].</b></p> <p>The speed increases up to 5 steps.</p> <ul style="list-style-type: none"> <li>• Press [▶] (PLAY) to restart play.</li> <li>• <b>VCD</b> Forward direction [▶▶] only.</li> <li>• The unit will pause if slow-motion play is continued for approximately 5 minutes (excluding <b>DVD-V</b> <b>DVD-A</b> <b>VCD</b>).</li> </ul>
<p><b>Frame-by-frame</b></p> <p>HDD RAM -R -R DL -RW(V) +R +R DL +RW DVD-V DVD-A (Motion picture parts only) -RW(VR) VCD</p>	<p><b>While paused, press [◀] (◀◀) or [▶] (▶▶).</b></p> <p>Each press shows the next frame.</p> <ul style="list-style-type: none"> <li>• Press and hold to change in succession forward or backward.</li> <li>• Press [▶] (PLAY) to restart play.</li> <li>• <b>VCD</b> Forward direction [▶] (▶▶) only.</li> </ul>
<p><b>Skipping the specified time (Time Slip)</b></p> <p>HDD RAM -R -R DL -RW(V) +R +R DL +RW -RW(VR)</p>	<p><b>1 Press [TIME SLIP].</b></p> <p><b>2 Press [▲, ▼] to select the time and press [ENTER].</b></p> <p>Play skips the specified time.</p> <ul style="list-style-type: none"> <li>• Each time you press [▲, ▼], the time increases [▲] or decreases [▼] by 1 minute intervals. (Press and hold for 10-minute intervals.)</li> </ul> <div data-bbox="984 622 1434 779" style="float: right; border: 1px solid black; padding: 5px;">  <p>This automatically disappears after approximately 5 seconds. To show the screen again press [TIME SLIP] again.</p> </div>
<p><b>Manual Skip</b></p> <p>HDD RAM -R -R DL -RW(V) +R +R DL +RW -RW(VR)</p>	<p><b>Press [MANUAL SKIP].</b></p> <p>Each time you press, play restarts approximately 30 seconds later.</p>
<p><b>Create Chapter</b> (⇒ 38, Title/Chapter)</p> <p>HDD RAM</p>	<p><b>Press [CREATE CHAPTER].</b></p> <p>Chapters are divided at the point pressed.</p> <ul style="list-style-type: none"> <li>• Press [◀◀, ▶▶] to skip to the start of a chapter.</li> </ul>

## Changing audio during play

### Press [AUDIO].

HDD RAM -RW(VR) VCD and DivX

LR→L→R

↑

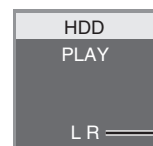

e.g., "L R" is selected

DVD-V DVD-A

You can change the audio channel number each time you press the button. This allows you to change things like the soundtrack language (⇒ 36, Soundtrack).



e.g., English is selected.

### Note

You cannot change the audio type in the following cases.

- When a DVD-R, DVD-R DL, DVD-RW (DVD-Video format), +R, +R DL or +RW disc is in the disc tray while DVD drive is selected.
- When the recording mode is XP and "Audio Mode for XP Recording" is set to "LPCM" (⇒ 60).
- When "Rec for High Speed Copy" is set to "On" (⇒ 22).

## Regarding DivX discs, MP3 discs and still pictures (JPEG/TIFF)

### DivX

Playable discs	<b>-R CD</b>
File format	DivX <ul style="list-style-type: none"> <li>Files must have the extension ".DIVX", ".divx", ".AVI" or ".avi".</li> </ul> 
Number of folders	Maximum number of folders recognizable: 300 folders (including the root folder)
Number of files	Maximum number of files recognizable*1: 200 files
Support version	DivX ver.3.11, 4.x, 5.x Video -Number of stream: Up to 1 -Codec: DIV3, DIV4, DIVX, DV50 -Picture size: 32 x 32 to 720 x 576 -FPS (Frame Per Second): Up to 30 fps Audio -Number of stream: Up to 8 -Format: MP3, MPEG, AC3 -Multi channel: AC3 is possible. MPEG multi is 2 ch conversion. GMC (Global Motion Compensation) is not supported.

### MP3

Playable discs	<b>CD</b>
File format	MP3 <ul style="list-style-type: none"> <li>Files must have the extension ".mp3" or ".MP3".</li> </ul>
Number of folders (groups)	Maximum number of folders (groups) recognizable: 300 folders (groups) (including the root folder)
Number of files (tracks)	Maximum number of files (tracks) recognizable*1: 3000 files (tracks)
Bit rates	32 kbps to 320 kbps
Sampling frequency	16 kHz/22.05 kHz/24 kHz/32 kHz/44.1kHz/48 kHz
ID3 tags	not compatible

\*1 If there is a large amount of still picture data etc. within a MP3 file, play may not be possible.

### Still pictures (JPEG, TIFF)\*2

Playable discs and cards	<b>HDD RAM CD SD</b>
File format	File format: JPEG, TIFF (non-compressed RGB chunky format) <ul style="list-style-type: none"> <li>Files must have the extension ".jpg", ".JPG", ".tif" or ".TIF".</li> </ul>
Number of pixels	34×34 to 6144×4096 (Sub sampling is 4:2:2 or 4:2:0)
Number of folders	<b>CD</b> Maximum number of folders recognizable:300 folders (including the root folder) <b>HDD RAM SD</b> This unit can handle a maximum of 300 folders (including higher folders)
Number of files	<b>CD</b> Maximum number of files recognizable*1:3000 files <b>HDD RAM SD</b> This unit can handle a maximum of 3000 files
MOTION JPEG	not supported

\*1 Total number of recognizable file including MP3, JPEG, DivX and other type of files is 4000.

\*2 Operation may take time to complete when playing TIFF format still pictures, or when there are many files and/or folders, some files may not display or be playable.

### -R CD

- CD** Compatible formats: ISO9660 level 1 or 2 (except for extended formats) and Joliet
- This unit is compatible with multi-session but reading or play of the disc may take time if there are a lot of sessions.
- Operation may take time to complete when there are many files (tracks) and/or folders (groups) and some files (tracks) may not display or be playable.
- English alphabet and Arabic numerals are displayed correctly. Other characters may not be displayed correctly.
- The display order on this unit may differ from how the order is displayed on a computer.
- Depending on how you create the disc (writing software), files (tracks) and folders (groups) may not play in the order you numbered them.
- This unit is not compatible with packet-write format.
- Depending on the recording conditions, the disc may not play.

### HDD RAM SD

- Compatible formats: DCF\*3 compliant (Content recorded on a digital camera, etc.)
- \*3 Design rule for Camera File system: unified standard established by Japan Electronics and Information Technology Industries Association (JEITA).

You can play MP3 and still pictures (JPEG/TIFF) on this unit by making folders as shown below. However depending on how you create the disc (writing software), play may not be in the order you numbered the folders.

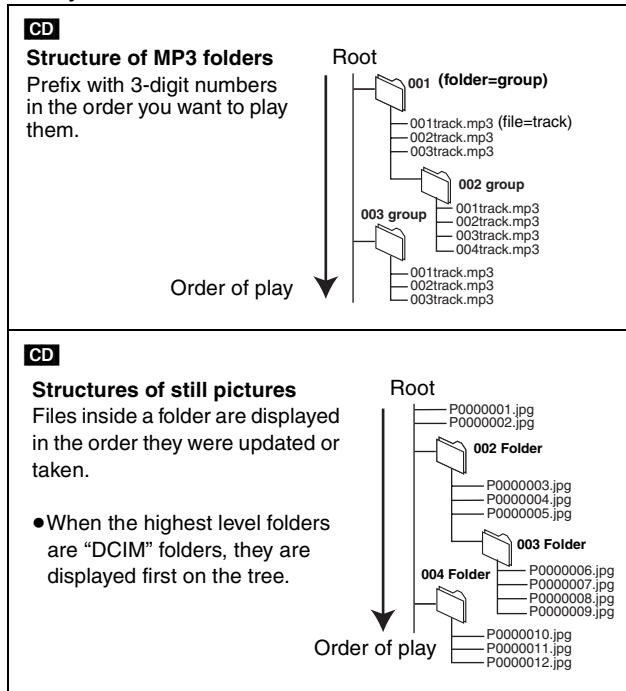

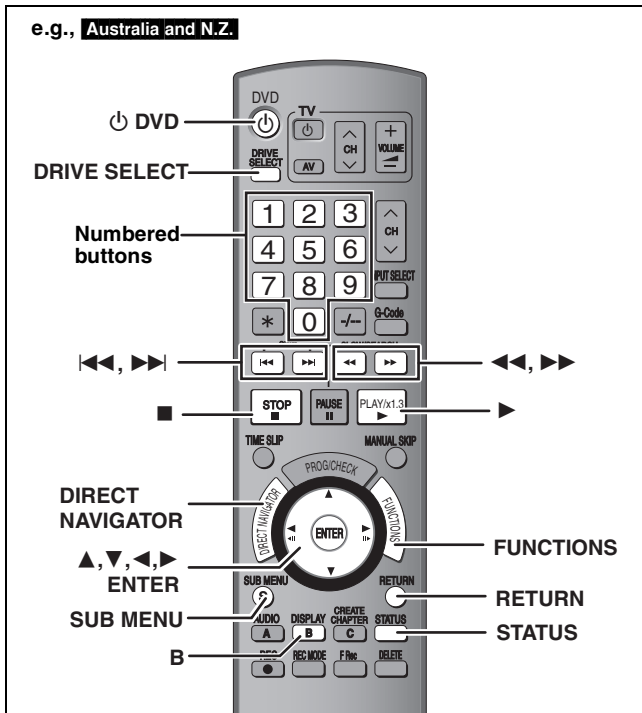

### Selecting file type to play

**CD**  
You can play CD-R/CD-RW discs which contain MP3 files, DivX video contents or still pictures that have been recorded on a computer.

The screen shown below is displayed when you insert a disc containing DivX video contents, MP3 files and still pictures (JPEG/TIFF).

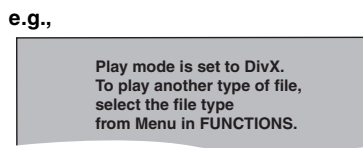

- When playing the file displayed on the screen Press [ENTER].
- When you want to play files other than the one displayed on the screen Follow the steps below.

#### To select file type

- 1 Press [RETURN].
- 2 Press [FUNCTIONS].

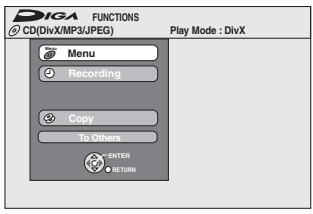

- 3 Press [▲, ▼] to select "Menu" and press [ENTER].

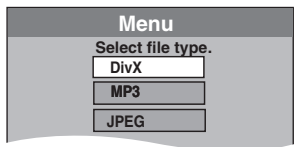

- 4 Press [▲, ▼] to select playback mode and press [ENTER].  
If "DivX" is selected: Go to "Playing DivX discs" step 2 in the right column.  
If "MP3" is selected: Go to "Playing MP3 discs" step 2 on page 33.  
If "JPEG" is selected: Go to "Playing still pictures" step 4 on page 34

### Playing DivX discs

**-R CD**  
You can play DVD-R and CD-R/CD-RW discs which contain DivX video contents that have been recorded on a computer.

**Preparation**  
Press [DRIVE SELECT] to select the DVD drive.

- 1 Press [DIRECT NAVIGATOR].

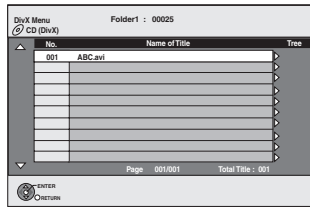

- Files are treated as titles.
- When the MP3 or JPEG Menu is displayed, perform steps 1-4 in "To select file type" on the left column selecting "DivX" in step 4 to change the playback mode.

- 2 Press [▲, ▼] to select the title and press [ENTER].

Play starts on the selected title.  
•You can also select the title with the numbered buttons.  
e.g., 5: [0] => [0] => [5]  
15: [0] => [1] => [5]

#### To stop playing

Press [■].

#### To show other pages

Press [◀▶].

#### To exit the screen

Press [DIRECT NAVIGATOR].

#### Note

- Picture sizes set at the recording time may prevent the unit from showing pictures in the adequate aspect. You may be able to adjust the aspect through the TV.
- Successive play is not possible.
- Playback is not possible if recording is performed on the HDD drive.

#### Using the tree screen to find a folder

- 1 While the file list is displayed Press [▶] while a title is highlighted to display the tree screen.

F: Selected folder no./Total folder no. including DivX title.

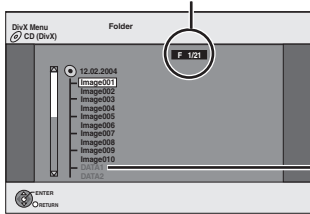

You cannot select folders that contain no compatible files.

- 2 Press [▲, ▼] to select a folder and press [ENTER].  
The file list for the folder appears.

#### To return to the previous screen

Press [RETURN].



## Regarding DivX VOD content

DivX Video-on-Demand (VOD) content is encrypted for copyright protection. In order to play DivX VOD content on this unit, you first need to register the unit.

Follow the on line instructions for purchasing DivX VOD content to enter the unit's registration code and register the unit. For more information about DivX VOD, visit [www.divx.com/vod](http://www.divx.com/vod)

### Display the unit's registration code.

(→ 61, "DivX Registration" in "Others" tab)

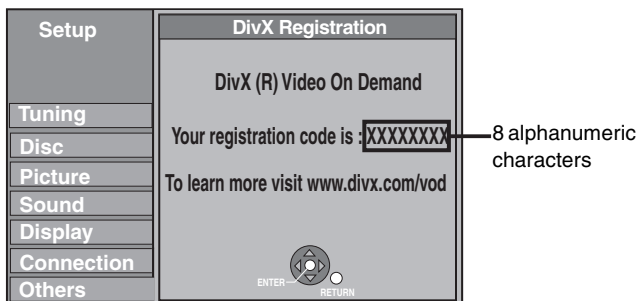

- After playing DivX VOD content for the first time, another registration code is then displayed in "DivX Registration". Do not use this registration code to purchase DivX VOD content. If you use this code to purchase DivX VOD content, and then play the content on this unit, you will no longer be able to play any content that you purchased using the previous code.
- If you purchase DivX VOD content using a registration code different from this unit's code, you will not be able to play this content. ("Authorization Error." is displayed.)

### Regarding DivX content that can only be played a set number of times

Some DivX VOD content can only be played a set number of times. When you play this content, the remaining number of plays is displayed. You cannot play this content when the number of remaining plays is zero. ("Rental Expired" is displayed.)

When playing this content

- The number of remaining plays is reduced by one if
  - you press [DVD].
  - you press [■].
  - you press [◀◀] or [◀▶, ▶▶] etc. and arrive at another content or the start of the content being played.
  - timer recording starts on the HDD.
  - you press [DRIVE SELECT] to change the drive.
- Resume functions do not work.

## Playing MP3 discs

### CD

You can play CD-R/CD-RW discs which contain MP3 files that have been recorded on a computer.

### Preparation

Press [DRIVE SELECT] to select the DVD drive.

## 1 Press [DIRECT NAVIGATOR].

G: Group No.  
T: Track No. in the group  
TOTAL: Track No./Total tracks in all groups

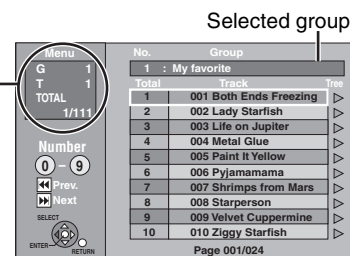

- Files are treated as tracks and folders are treated as groups.
- When the DivX or JPEG Menu is displayed, perform steps 1–4 in "To select file type" on page 32 selecting "MP3" in step 4 to change the playback mode.

## 2 Press [▲, ▼] to select the track and press [ENTER].

Play starts on the selected track.

- "☞" indicates the track currently playing.
- You can also select the track with the numbered buttons.  
e.g., 5: [0] → [0] → [0] → [5]  
15: [0] → [0] → [1] → [5]

### To stop playing

Press [■].

### To show other pages

Press [◀◀, ▶▶].

### To exit the screen

Press [DIRECT NAVIGATOR].

## Using the tree screen to find a group

### 1 While the file list is displayed

Press [▶] while a track is highlighted to display the tree screen.

Selected group No./Total groups

If the group has no track, "–" is displayed as group number.

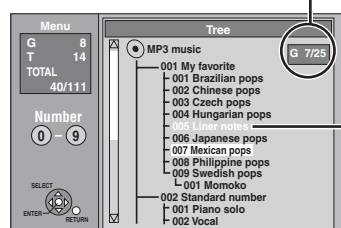

## 2 Press [▲, ▼, ◀, ▶] to select a group and press [ENTER].

The file list for the group appears.

### To return to the previous screen

Press [RETURN].

Refer to the control reference on page 32.

## Playing still pictures

### HDD RAM CD SD

- You can use SD Memory Cards with capacities from 8 MB to 2 GB (→ 7).
- You can playback still pictures recorded onto a CD-R/CD-RW on a PC.
- You cannot playback still pictures while recording or copying.
- Inserting, Removing the SD card (→ 13)

While stopped put the card in the slot, and the menu (→ below) is automatically displayed.

Press [▲, ▼] to select “Album View” and then press [ENTER] to display the Album View screen shown in step 2.

### 1 Press [DRIVE SELECT] to select the HDD, DVD or SD drive.

The indicator lights up on the unit’s display.

### 2 Press [DIRECT NAVIGATOR].

#### • HDD RAM SD

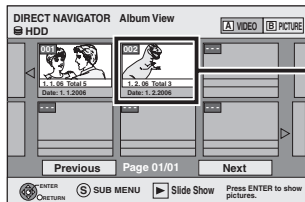

Album View screen

Recording date of the first picture in the album/ number of pictures/ album name.

Depending on the digital camera, the editing software on the PC etc., the information about the recording date may not be displayed. In this case, the date will appear as [--.--.--].

**HDD RAM** If “VIDEO” is selected, press [B] to select “PICTURE”.

#### • CD

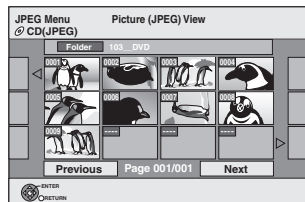

Picture (JPEG) View screen

### (→ Go to step 4)

When the DivX or MP3 Menu is displayed, perform steps 1–4 in “To select file type” on page 32 selecting “JPEG” in step 4 to change the playback mode.

#### Direct Navigator screen icons

- Picture and folder protected.
- Picture in which the number of prints is set (DPOF) (→ 43, 73).

#### To show other pages

Press [▲, ▼, ◀, ▶] to select “Previous” or “Next” and press [ENTER].

- You can also press [◀◀, ▶▶] to show other pages.

To select the still pictures in another folder → 35

### 3 Press [▲, ▼, ◀, ▶] to select the album and press [ENTER].

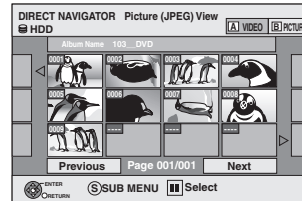

e.g., HDD

You can also select album with the numbered buttons.

- e.g.,
- 5: [0] → [0] → [5]
  - 15: [0] → [1] → [5]
  - 115: [1] → [1] → [5]

- Press [◀, ▶] to select the previous or next album.

### 4 Press [▲, ▼, ◀, ▶] to select the still picture and press [ENTER].

You can also select still pictures with the numbered buttons.

- e.g.,
- 5: [0] → [0] → [0] → [5]      115: [0] → [1] → [1] → [5]
  - 15: [0] → [0] → [1] → [5]      1115: [1] → [1] → [1] → [5]

- Press [◀, ▶] to display the previous or next still picture.
- Useful functions during still picture play (→ 35)

#### To return to the Album View screen or Picture (JPEG) View screen

Press [RETURN].

#### To exit the screen

Press [DIRECT NAVIGATOR].

## Useful functions during still picture play

### Start Slide Show Slide Show Setting

You can display still pictures one by one at a constant interval.

#### HDD RAM SD

- 1 While the Album View screen is displayed  
Press [**▲**, **▼**, **◀**, **▶**] to select the album.
- 2 Press [**▶**] (PLAY).

You can also start Slide Show with the following steps.

While the Album View screen is displayed

- 1 Press [**▲**, **▼**, **◀**, **▶**] to select the desired album and press [SUB MENU].
- 2 Press [**▲**, **▼**] to select "Start Slide Show" and press [ENTER].



#### CD

While the Picture (JPEG) View screen is displayed

- 1 Press [**▲**, **▼**, **◀**, **▶**] to select "Folder" and press [SUB MENU].
- 2 Press [**▲**, **▼**] to select "Start Slide Show" and press [ENTER].

#### •To change the display interval

- 1 Press [**▲**, **▼**] to select "Slide Show Setting" in step 2 and press [ENTER].
- 2 Press [**▲**, **▼**] to select "Display interval".
- 3 Press [**◀**, **▶**] to select the desired interval (0–30 seconds) and press [ENTER].

#### •Repeat Play

- 1 Press [**▲**, **▼**] to select "Slide Show Setting" in step 2 and press [ENTER].
- 2 Press [**▲**, **▼**] to select "Repeat Play".
- 3 Press [**◀**, **▶**] to select "On" or "Off" and press [ENTER].

### Rotate

While playing

- 1 Press [SUB MENU].
- 2 Press [**▲**, **▼**] to select "Rotate RIGHT" or "Rotate LEFT" and press [ENTER].

#### •Rotation information will not be stored.

- **CD** Still pictures
- When disc or album is protected
- When played on other equipment
- When copying pictures

- If you remove the SD card while the DIRECT NAVIGATOR screen is displayed, picture rotation information may not be properly stored. Remove the SD card after you exit the DIRECT NAVIGATOR screen.



### Zoom in Zoom out

While playing

- 1 Press [SUB MENU].
- 2 Press [**▲**, **▼**] to select "Zoom in" and press [ENTER].

- To return the picture to its original size, press [**▲**, **▼**] to select "Zoom out" in step 2 and press [ENTER].

- When zooming in, the picture may be cut off.
- The enlargement information will not be stored.
- The "Zoom in/Zoom out" function is only available for still pictures smaller than 640 × 480 pixels.

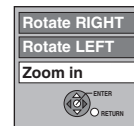

### Properties

While playing

Press [STATUS] twice.

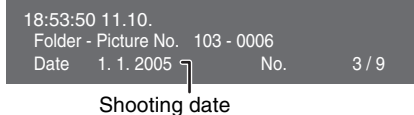

To exit the picture properties screen  
Press [STATUS].

## ■ To select the still pictures in another folder

(⇒ 7, Structure of folders displayed by this unit)

#### RAM SD

To switch to another higher folder

(Only if there is a multiple number of higher folders recognizable)

- 1 While the Album View screen is displayed  
Press [SUB MENU].
- 2 Press [**▲**, **▼**] to select "Select Folder" and press [ENTER].



- 3 Press [**◀**, **▶**] to select the higher folder and press [ENTER].

#### CD

- 1 While the Picture (JPEG) View screen is displayed  
Press [**▲**, **▼**, **◀**, **▶**] to select "Folder" and press [ENTER].
- 2 Press [**▲**, **▼**] to select the folder and press [ENTER].

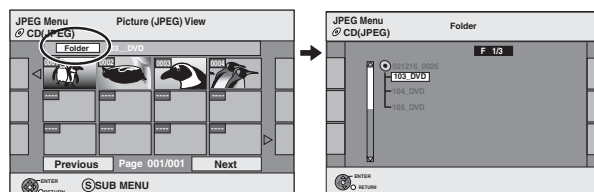

e.g., **Australia and N.Z.**

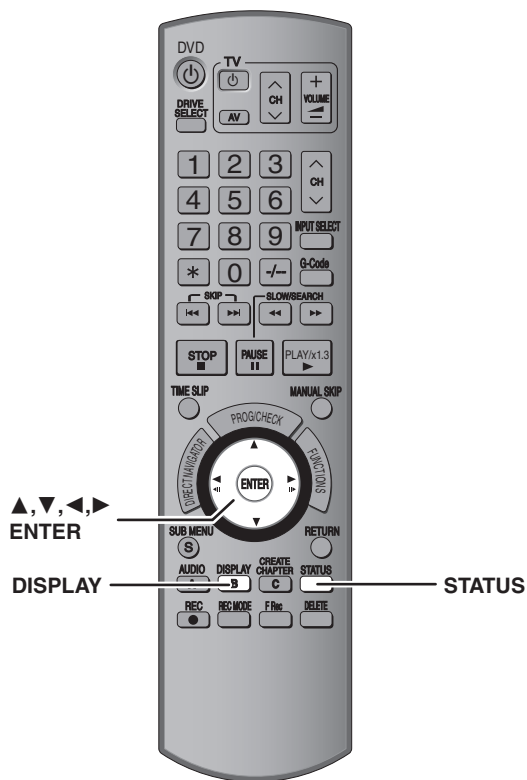

## Using on-screen menus

### Common procedures

#### 1 Press [DISPLAY].

Disc	Soundtrack	1	DD Digital 2/0 ch
Play	Subtitle	Off	
Picture	Audio channel	L R	
Sound			
Other			
Menu	Item	Setting	

- Depending on the condition of the unit (playing, stopped, etc.) and disc contents, there are some items that you cannot select or change.

#### 2 Press [▲, ▼] to select the menu and press [▶].

#### 3 Press [▲, ▼] to select the item and press [▶].

#### 4 Press [▲, ▼] to select the setting.

- Some items can be changed by pressing [ENTER].

#### To clear the on-screen menus

Press [DISPLAY].

### Disc menu—Setting the disc content

#### Soundtrack\*

**HDD RAM -R -R DL -RW(V) +R +R DL +RW -RW(VR)**

The disc's audio attributes appear.

**DVD-V DVD-A**

Select the audio and language (⇒ below, Audio attribute, Language).

#### DivX

Select the soundtrack number.

- Soundtrack numbers are displayed even when there is only one audio type.

#### Subtitle\*

**DVD-V DVD-A**

Turn the subtitle on/off and select the language (⇒ below, Language).

**HDD RAM -R -R DL -RW(V) +R +R DL +RW -RW(VR)** (Only discs that contain subtitle on/off information)

Turn the subtitle on/off.

- Subtitle on/off information cannot be recorded using this unit.

#### DivX

Turn the subtitle on/off and select the subtitle number.

- Subtitle numbers are displayed even if there are not multiple subtitles.

#### Angle\* **DVD-V DVD-A**

Change the number to select an angle.

#### Audio channel **HDD RAM -RW(VR) VCD** and DivX

⇒ 30, Changing audio during play

#### STILL-P (Still picture) **DVD-A**

Selects the play method for still pictures.

**Slide Show:** Plays according to the default order on the disc.

**Page:** Select the still picture number and play.

• **RANDOM:** Plays in random order.

• **Return:** Returns to the default still picture on the disc.

#### Source Select (DivX)

• **Automatic:** The constructing method of the DivX contents is automatically distinguished and output.

• **Interlace:** Select when the disc contents were recorded using interlace.

• **Progressive:** Select when the disc contents were recorded using progressive.

#### PBC (Playback control ⇒ 73) **VCD**

Indicates whether menu play (playback control) is on or off.

\* With some discs, you may only be able to make changes using the menus (⇒ 29) on the disc.

- The display changes according to the disc content. You cannot change when there is no recording.

#### Audio attribute

LPCM/PPCM/DD Digital/DTS/MPEG: Signal type  
 k (kHz): Sampling frequency  
 b (bit): Number of bits  
 ch (channel): Number of channels

#### Language

ENG: English      SVE: Swedish      CHI: Chinese  
 FRA: French      NOR: Norwegian      KOR: Korean  
 DEU: German      DAN: Danish      MAL: Malay  
 ITA: Italian      POR: Portuguese      VIE: Vietnamese  
 ESP: Spanish      RUS: Russian      THA: Thai  
 NLD: Dutch      JPN: Japanese      \*: Others

### Play menu—Change the play sequence

This function works only when the elapsed play time is displayed. Select the item for repeat play. Depending on the disc, the items that can be selected will differ.

#### Repeat Play

- All CD VCD
- Chapter HDD RAM -R -R DL -RW(V) +R +R DL  
+RW DVD-V -RW(VR)
- Group DVD-A and MP3
- PL (Playlist) HDD RAM -RW(VR)
- Title HDD RAM -R -R DL -RW(V) +R +R DL  
+RW DVD-V -RW(VR)
- Track DVD-A CD VCD and MP3

Select "Off" to cancel.

### Picture menu—Change the picture quality

#### Playback NR

Reduces noise and picture degradation.

#### Progressive\* (⇒ 73)

Select "On" to enable progressive output.  
Select "Off" if the picture is stretched horizontally.

#### Transfer\* [When "Progressive" (⇒ above) is set to "On".]

Select the method of conversion for progressive output to suit the type of title being played (⇒ 73, Film and video).

When the output signal is PAL  
(When the tray is opened, the setting will return to "Auto".)

- **Auto:** Automatically detects the film and video content, and appropriately converts it.
- **Video:** Select when using "Auto", and the content is distorted.
- **Film:** Select this if the edges of the film content appear jagged or rough when "Auto" is selected. However, if the video content is distorted as shown in the illustration to the right, then select "Auto".

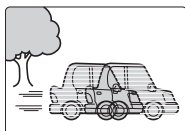

When the output signal is NTSC

- **Auto1** (normal): Automatically detects the film and video content, and appropriately converts it.
- **Auto2:** In addition to "Auto1", automatically detects film contents with different frame rates and appropriately converts it.
- **Video:** Select when using "Auto1" and "Auto2", and the content is distorted.

#### AV-in NR (Only when AV1, AV2, AV3, AV4 or DV is selected)

Reduces video tape noise while copying.

- **Automatic:** Noise reduction only works on picture input from a video tape.
- **On:** Noise reduction works for input video.
- **Off:** Noise reduction is off. You can record the input signal as it is.

\* Only when you have set "Progressive" to "On" in the Setup menu (⇒ 18).

### Sound menu—Change the sound effect

#### V.S.S.

HDD RAM -R -R DL -RW(V) +R +R DL +RW DVD-V DVD-A -RW(VR)

(Dolby Digital, MPEG, 2-channel or over only)

Enjoy a surround-like effect if you are using two front speakers only.

- Turn V.S.S. off if it causes distortion. (Check the surround function on the connected equipment.)
- V.S.S. does not work for bilingual recordings.

#### Dialog Enhancer

HDD RAM -R -R DL -RW(V) +R +R DL +RW DVD-V DVD-A -RW(VR) and DivX

(Dolby Digital, 3-channel or over only, including a centre channel)

The volume of the centre channel is raised to make dialogue easier to hear.

### Other menu—Change the display position

#### Position

1–5: The higher the setting the lower the on-screen menu moves.

## Status messages

### Press [STATUS].

The display changes each time you press the button.

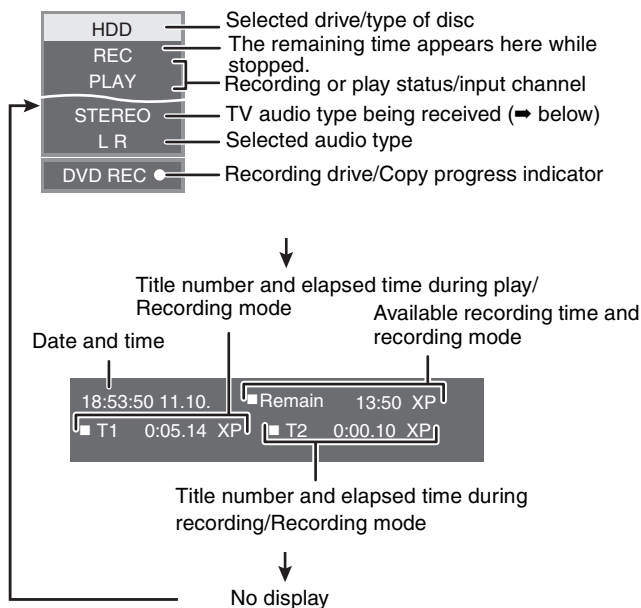

#### • TV audio type

- STEREO:** STEREO stereo broadcast
- M 1/M 2:** Bilingual dual-sound broadcast
- M 1:** Monaural broadcast

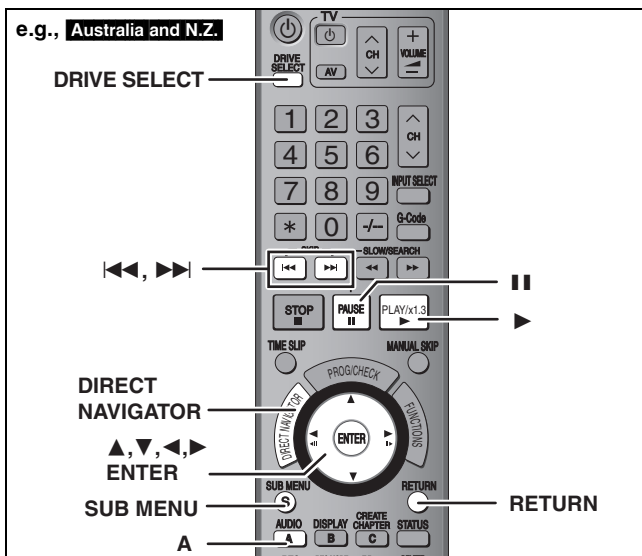

**HDD RAM -R -R DL -RW(V) +R +R DL +RW -RW(VR)**  
 (You cannot edit finalized discs.)

## Title/Chapter

Programmes are recorded as a single title consisting of one chapter.

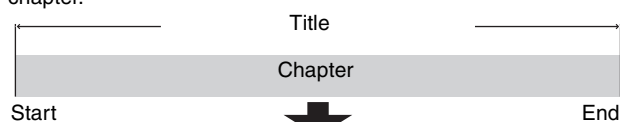

**HDD RAM** You can divide a title into multiple chapters. Each section between the division points becomes a chapter. (⇒ 30, 39, Create Chapter)

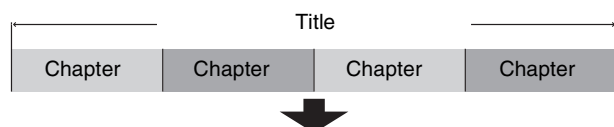

**HDD RAM** You can change the order of chapters and create a playlist (⇒ 40).

• The maximum number of items on a disc:

### HDD

- Titles: 500
- Chapters: Approx. 1000 per title  
(Depends on the state of recording.)

### RAM -R -R DL -RW(V) +R +R DL +RW

- Titles: 99 (+R +R DL +RW 49 titles)
- Chapters: Approx. 1000 (+R +R DL +RW Approx. 254)  
(Depends on the state of recording.)

### Note

- Once deleted, divided or partially deleted, recorded content cannot be restored to its original state. Make certain before proceeding.
- You cannot edit during recording or copying, etc.
- Restricted recording information remains even after editing (e.g. dividing a title etc).
- **+R +R DL** Each time you edit a title the information is saved to the free space on the disc. If you do this numerous times, the amount of free space decreases.  
We recommend that you edit on the HDD and then copy to disc.

## Editing titles/chapters and playing chapters

You can modify (remove unnecessary parts, divide, etc.) recorded programmes.

### Preparation

- Turn on the television and select the appropriate video input to suit the connection to this unit.
- Turn the unit on.
- Press [DRIVE SELECT] to select the drive containing the recorded title to be edited.
- **RAM** Release protection (⇒ 53).

- 1 During play or while stopped  
Press [DIRECT NAVIGATOR].
- 2 **HDD RAM**  
Press [A] to select "VIDEO".
- 3 Press [▲, ▼, ◀, ▶] to select the title.

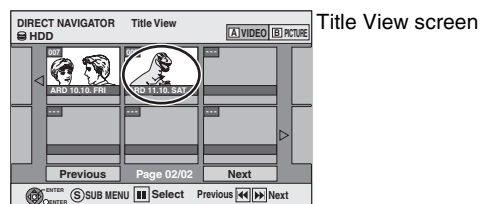

### To show other pages

Press [▲, ▼, ◀, ▶] to select "Previous" or "Next" and press [ENTER].

• You can also press [◀◀, ▶▶] to show other pages.

### Multiple editing

Select with [▲, ▼, ◀, ▶] and press [III]. (Repeat.)  
A check mark appears. Press [III] again to cancel.

- 4 Press [SUB MENU].
- 5 Press [▲, ▼] to select the operation and press [ENTER].

• If you select "Edit", press [▲, ▼] to select the operation and press [ENTER]. (⇒ 39)

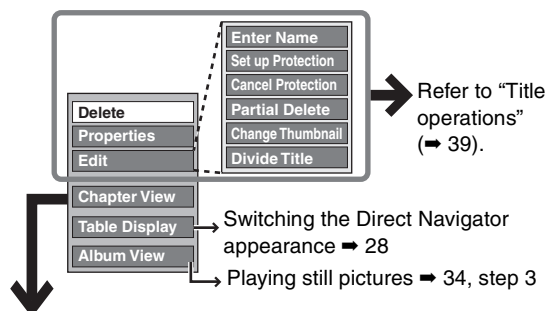

■ If you select "Chapter View"

- 6 Press [▲, ▼, ◀, ▶] to select the chapter.

To start play ⇒ Press [ENTER].  
To edit ⇒ Step 7.

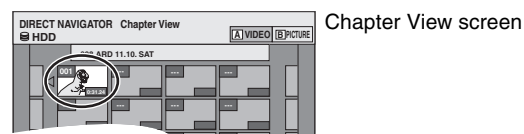

• To show other pages/Multiple editing (⇒ above)

- 7 Press [SUB MENU], then [▲, ▼] to select the operation and press [ENTER].

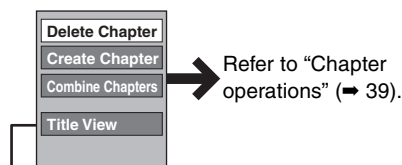

• You can go back to Title View.

### To return to the previous screen

Press [RETURN].

### To exit the screen

Press [DIRECT NAVIGATOR].



## Title operations

After performing steps 1–5 (⇒ 38)

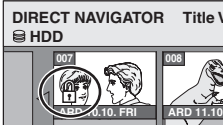
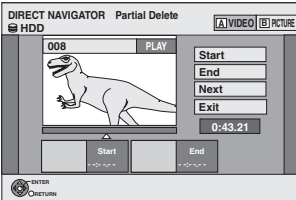
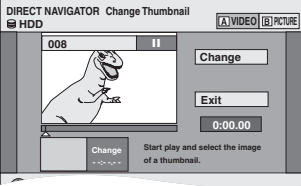
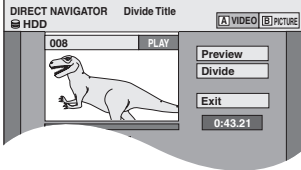
<p><b>Delete*</b></p> <p>HDD RAM -R -R DL -RW(V) +R +R DL +RW</p>	<p>Press [◀, ▶] to select “Delete” and press [ENTER].</p> <ul style="list-style-type: none"> <li>Once deleted, the recorded contents are lost and cannot be restored. Make certain before proceeding.</li> <li>The available recording space on DVD-R, DVD-R DL, +R or +R DL does not increase when you delete titles.</li> <li>Available recording space on DVD-RW (DVD-Video format) and +RW increases only when the last recorded title is deleted. It does not increase if other titles are deleted.</li> </ul>
<p><b>Properties</b></p> <p>HDD RAM -R -R DL -RW(V) +R +R DL +RW -RW(VR)</p>	<p>Information (e.g., time and date) is shown.</p> <ul style="list-style-type: none"> <li>Press [ENTER] to exit the screen.</li> </ul> 
<p><b>Enter Name</b></p> <p>HDD RAM -R -R DL -RW(V) +R +R DL +RW</p>	<p>You can give names to recorded titles.</p> <p>⇒ 56, Entering text</p>
<p><b>Set up Protection*</b></p> <p><b>Cancel Protection*</b></p> <p>HDD RAM +R +R DL +RW</p>	<p>If set, this will protect the title from accidental deletion.</p> <p>Press [◀, ▶] to select “Yes” and press [ENTER].</p> <p>The lock symbol appears when the title is protected.</p> 
<p><b>Partial Delete</b></p> <p>HDD RAM</p> <p>(⇒ below, For your reference)</p>	<p>You can remove unnecessary part of the recording.</p> <ol style="list-style-type: none"> <li>Press [ENTER] at the start point and end point of the section you want to delete.</li> <li>Press [▲, ▼] to select “Exit” and press [ENTER]. <ul style="list-style-type: none"> <li>Select “Next” and press [ENTER] to delete other sections.</li> </ul> </li> <li>Press [◀, ▶] to select “Delete” and press [ENTER].</li> </ol> 
<p><b>Change Thumbnail</b></p> <p>HDD RAM +R -R DL -RW(V) +R +R DL +RW</p> <p>(⇒ below, For your reference)</p>	<p>You can change an image to be shown as the thumbnail picture in the Title View.</p> <ol style="list-style-type: none"> <li>Press [▶] (PLAY) to start play.</li> <li>Press [ENTER] when the image you want to use as a thumbnail is shown. <p>To change the thumbnail</p> Restart play and press [▲, ▼] to select “Change”, then press [ENTER] at the point you want to change.</li> <li>Press [▲, ▼] to select “Exit” and press [ENTER].</li> </ol> 
<p><b>Divide Title</b></p> <p>HDD RAM</p> <p>(⇒ below, For your reference)</p>	<p>You can divide a title into two.</p> <ol style="list-style-type: none"> <li>Press [ENTER] at the point you want to divide the title.</li> <li>Press [▲, ▼] to select “Exit” and press [ENTER].</li> <li>Press [◀, ▶] to select “Divide” and press [ENTER]. <p>To confirm the division point</p> Press [▲, ▼] to select “Preview” and press [ENTER]. (The unit plays 10 seconds before and after the division point.)</li> </ol> <p>To change the division point</p> Restart play and press [▲, ▼] to select “Divide”, then press [ENTER] at the point where you want to divide the title. <p><b>Note</b></p> <ul style="list-style-type: none"> <li>The divided titles retain the title name and CPRM property (⇒ 73) of the original title.</li> <li>Video and audio just before and after the dividing point may momentarily cut out.</li> </ul> 

\* Multiple editing is possible.

## Chapter operations

After performing steps 1–7 (⇒ 38)

<p><b>Delete Chapter*</b></p> <p>HDD RAM</p>	<p>Press [◀, ▶] to select “Delete” and press [ENTER].</p> <ul style="list-style-type: none"> <li>Once deleted, the recorded contents are lost and cannot be restored. Make certain before proceeding.</li> <li>Select “Combine Chapters” (⇒ below) when you only want to delete the division point between chapters. (The recorded contents will not be deleted.)</li> </ul>
<p><b>Create Chapter</b></p> <p>HDD RAM</p> <p>(⇒ below, For your reference)</p>	<p>Select the point where you want to start a new chapter while viewing the title.</p> <ol style="list-style-type: none"> <li>Press [ENTER] at the point you want to divide. <ul style="list-style-type: none"> <li>Repeat this step to divide at other points.</li> </ul> </li> <li>Press [▲, ▼] to select “Exit” and press [ENTER].</li> </ol> 
<p><b>Combine Chapters</b></p> <p>HDD RAM</p>	<p>Press [◀, ▶] to select “Combine” and press [ENTER].</p> <ul style="list-style-type: none"> <li>The selected chapter and following chapter are combined.</li> </ul>

\* Multiple editing is possible.

### For your reference

- Use search (⇒ 29), Time Slip (⇒ 30) to find the desired point.
- To find the desired point correctly, use Slow-motion (⇒ 30) and Frame-by-frame (⇒ 30).
- To skip to the start or end of a title, press [◀◀] (start) or [▶▶] (end).

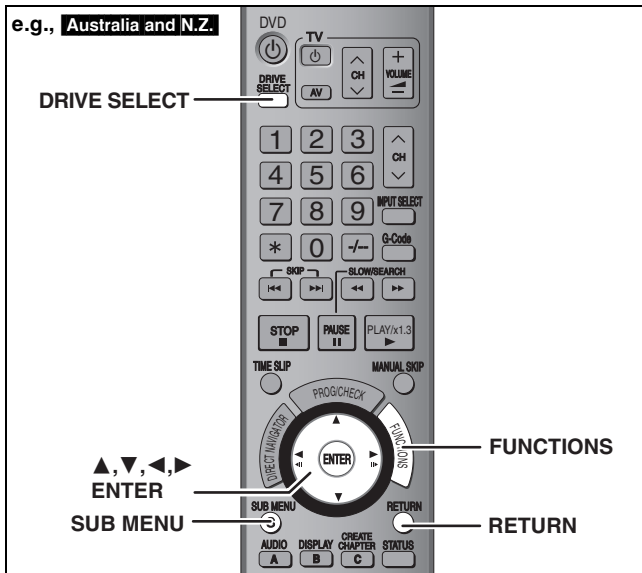

You can arrange the chapters (⇒ 38) to create a playlist.

Title			Title	
Chapter	Chapter	Chapter	Chapter	Chapter

↓

Playlist

Chapter	Chapter
---------	---------

↓

Copying (⇒ 45) a playlist will create a title.

- Playlists are not recorded separately so this doesn't use much capacity.
- Editing chapters in a playlist does not modify the source titles and source chapters.
- You cannot create or edit playlists while recording or copying.

## HDD RAM

- The maximum number of items on a disc:
  - Playlists: 99
  - Chapters in playlists: Approx. 1000 (Depends on the state of recording.)
- If you exceed the maximum numbers of items for a disc, all the items entered will not be recorded.

## Creating playlists

### HDD RAM

#### Preparation

- Turn on the television and select the appropriate Video input to suit the connection to this unit.
- Turn the unit on.
- Press [DRIVE SELECT] to select the drive containing the recorded title to be edited.
- **RAM** Release disc or cartridge protection (⇒ 53).
- You cannot create or edit a playlist while recording or while copying.
- Playlists must be made in accordance with the encoding system currently selected in "TV System" (⇒ 63).

- 1 While stopped  
Press [FUNCTIONS].
- 2 Press [▲, ▼] to select "To Others" and press [ENTER].

e.g., **Australia and N.Z.**

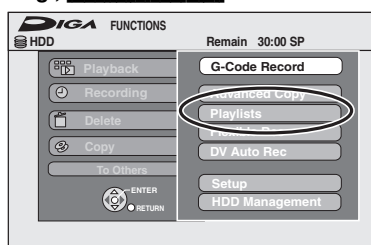

- 3 Press [▲, ▼] to select "Playlists" and press [ENTER].
- 4 Press [▲, ▼, ◀, ▶] to select "Create" and press [ENTER].

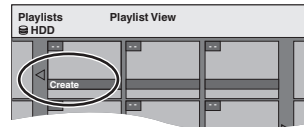

- 5 Press [◀, ▶] to select the source title and press [▼].

- Press [ENTER] to select all the chapters in the title, then skip to step 7.

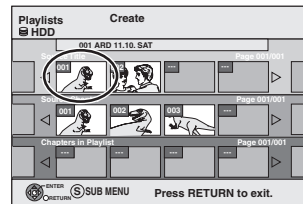

- 6 Press [◀, ▶] to select the chapter you want to add to a playlist and press [ENTER].

Press [▲] to cancel.

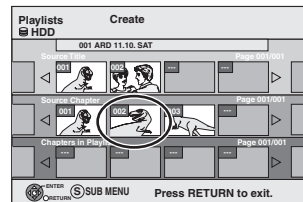

- You can also create a new chapter from the source title. Press [SUB MENU] to select "Create Chapter" and press [ENTER] (⇒ 39, Create Chapter)

- 7 Press [◀, ▶] to select the position to insert the chapter and press [ENTER].

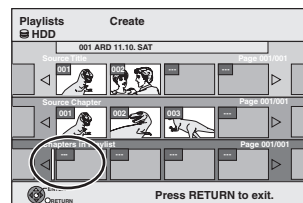

- Press [▲] to select other source titles.
- Repeat steps 6–7 to add other chapters.

- 8 Press [RETURN].

All the selected scenes become the playlist.

#### To return to the previous screen

Press [RETURN].

#### To exit the screen

Press [RETURN] several times.

## Editing and playing playlists/chapters

**HDD RAM**

**-RW(VR)** (Play only)

- 1** While stopped  
Press [FUNCTIONS].
- 2** Press [▲, ▼] to select “To Others” and press [ENTER].
- 3** Press [▲, ▼] to select “Playlists” and press [ENTER].
- 4** Press [▲, ▼, ◀, ▶] to select the playlist.  
To start play → Press [ENTER].  
To edit → Step 5.



• To show other pages/Multiple editing (⇒ 38)

- 5** Press [SUB MENU], then [▲, ▼] to select the operation and press [ENTER].

• If you select “Edit”, press [▲, ▼] to select the operation and press [ENTER].

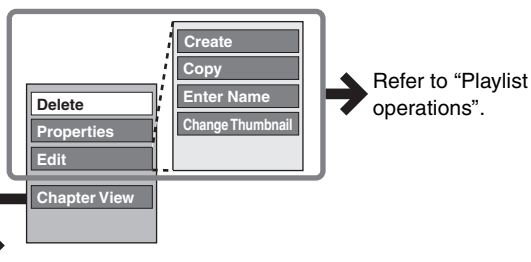

### ■ If you select “Chapter View”

- 6** Press [▲, ▼, ◀, ▶] to select the chapter.  
To start play → Press [ENTER].  
To edit → Step 7.

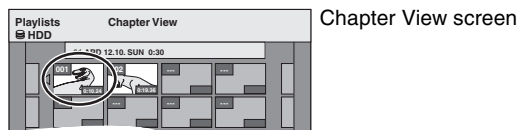

• To show other pages/Multiple editing (⇒ 38)

- 7** Press [SUB MENU], then [▲, ▼] to select the operation and press [ENTER].

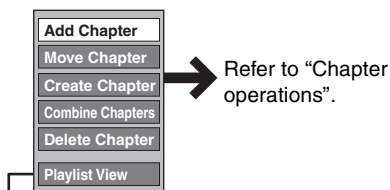

• You can go back to Playlist View.

**To return to the previous screen**

Press [RETURN].

**To exit the screen**

Press [RETURN] several times.

## Playlist operations

After performing steps 1–5 (⇒ left)

<b>Delete*</b> <b>HDD RAM</b>	Press [◀, ▶] to select “Delete” and press [ENTER]. Once deleted, the playlists are lost and cannot be restored. Make certain before proceeding.
<b>Properties</b> <b>HDD RAM</b> <b>-RW(VR)</b>	Playlist information (e.g., total time and date) is shown. • Press [ENTER] to exit the screen.
<b>Create</b> <b>HDD RAM</b>	⇒ 40, Creating playlists, Step 5–8
<b>Copy*</b> <b>HDD RAM</b>	Press [◀, ▶] to select “Copy” and press [ENTER]. • The copied playlist becomes the newest one in the playlist view screen.
<b>Enter Name</b> <b>HDD RAM</b>	You can give names to playlists. ⇒ 56, Entering text
<b>Change Thumbnail</b> <b>HDD RAM</b>	⇒ 39, Change Thumbnail



\* Multiple editing is possible.

## Chapter operations

**HDD RAM**

After performing steps 1–7 (⇒ left)

• Editing chapters in a playlist does not modify the source titles and source chapters.

<b>Add Chapter</b>	⇒ 40, Creating playlists, Step 5–7
<b>Move Chapter</b>	Press [▲, ▼, ◀, ▶] to select the position to insert the chapter and press [ENTER].
<b>Create Chapter</b>	⇒ 39, Create Chapter
<b>Combine Chapters</b>	⇒ 39, Combine Chapters
<b>Delete Chapter*</b>	⇒ 39, Delete Chapter The playlist itself is deleted if you delete all the chapters in it.

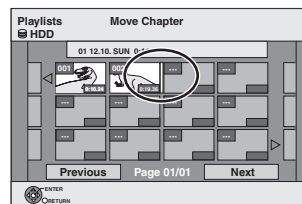

\* Multiple editing is possible.

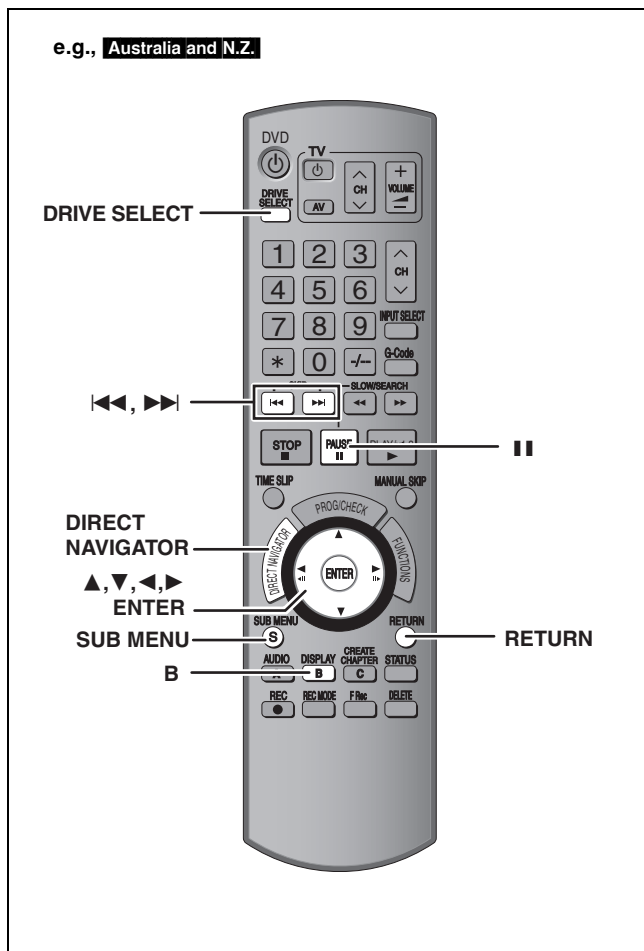

## HDD RAM SD

- You can edit pictures and albums.
- You can use SD Memory Cards with capacities from 8 MB to 2 GB (⇒ 7).
- You cannot edit still pictures recorded on CD-R/CD-RW.

### Preparation

- Press [DRIVE SELECT] to select the HDD, DVD or SD drive.
- **RAM SD** Release protection (⇒ 53, Setting the protection).

**1** Press [DIRECT NAVIGATOR].

**2** **HDD RAM**

Press [B] to select “PICTURE”.

**3** Editing an album:

Select the album to be edited and press [SUB MENU].

- When you want to create an album using “Create Album”, press [SUB MENU] without selecting album.

Editing a still picture:

**1** Select the album which contains the still picture to edit and press [ENTER].

**2** Select the still pictures to edit and press [SUB MENU].

### To show other pages

Press [▲, ▼, ◀, ▶] to select “Previous” or “Next” and press [ENTER].

- You can also press [◀◀, ▶▶] to show other pages.

### Multiple editing

Select with [▲, ▼, ◀, ▶] and press [■]. (Repeat.)

A check mark appears. Press [■] again to cancel.

- To switch to another higher folder (⇒ 35)

**4** Press [▲, ▼] to select the operation and press [ENTER].

### ■ To edit the album

(e.g., **SD**)

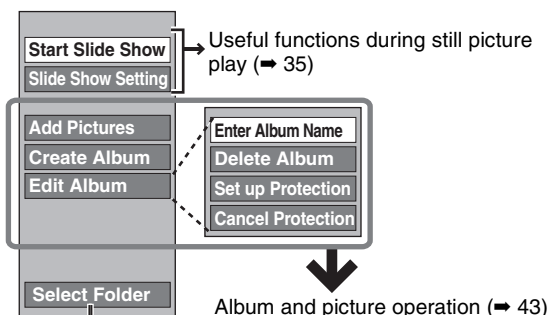

## RAM SD

This is only displayed when there are other higher folders that can be viewed.

To switch to another higher folder (⇒ 35)

### ■ To edit still picture

(e.g., **SD**)

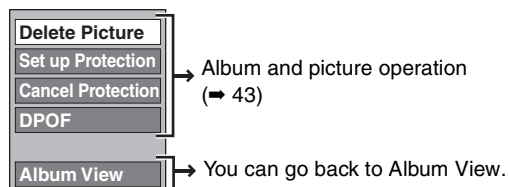

### To return to the previous screen



Press [RETURN].

### To exit the screen

Press [DIRECT NAVIGATOR].

## Album and picture operation

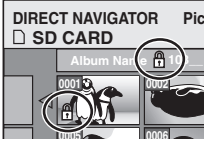
After performing steps 1–4, page 42

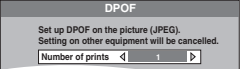
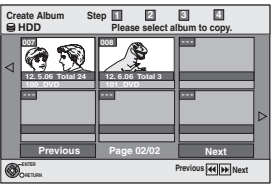
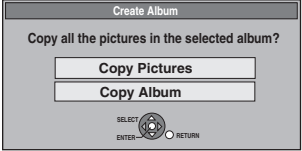
<p>Delete Picture* Delete Album* HDD RAM SD</p>	<p><b>Press [◀, ▶] to select “Delete” and press [ENTER].</b></p> <ul style="list-style-type: none"> <li>Once deleted, the recorded contents are lost and cannot be restored. Make certain before proceeding.</li> <li>When deleting an album, files other than the still picture files inside the album will also be deleted. (This does not apply to folders under the album concerned.)</li> </ul>
<p>Enter Album Name HDD RAM SD</p>	<p>You can give names to albums.</p> <ul style="list-style-type: none"> <li>56, Entering text</li> <li>Album names input using this unit may not be displayed on other equipment.</li> </ul>
<p>Set up Protection* Cancel Protection* HDD RAM SD</p>	<p>If set, this will protect the still picture or album from accidental deletion.</p> <p><b>Press [◀, ▶] to select “Yes” and press [ENTER].</b></p> <p>The lock symbol appears when the still picture or album is protected.</p> <ul style="list-style-type: none"> <li>Even if the protection setting is used by this unit to protect an album, the album may be deleted by another unit.</li> </ul> 
<p>DPOF* SD</p>	<p>You can select individual pictures for printing and specify the number of prints to be made.</p> <p><b>Press [◀, ▶] to select number of print (0 to 9) and press [ENTER].</b></p> <p>The DPOF mark appears.</p>  <p><b>To cancel the print setting</b> Set the number of print to “0”.</p> <ul style="list-style-type: none"> <li>Print settings (DPOF) made using this unit may not be viewable on other equipment.</li> <li>When this is set by this unit, any settings established by other units will be released.</li> <li>Settings cannot be made for files not in accordance with DCF standards or if there is no remaining space on the card.</li> </ul> 
<p>Add Pictures Create Album HDD RAM SD</p>	<p>① <b>Press [◀, ▶] to select “Start” or “Yes” and press [ENTER].</b></p> <p>e.g.,</p>  <p>② <b>Press [▲, ▼, ◀, ▶] to select the album that contains the still picture you want to add and press [ENTER].</b></p> <p>e.g.,</p>  <p><b>RAM SD</b></p> <p>To switch to another higher folder</p> <ol style="list-style-type: none"> <li>Press [SUB MENU].</li> <li>Select “Select Folder” and press [ENTER].</li> <li>Press [◀, ▶] to select the higher folder and press [ENTER].</li> </ol> <p>③ <b>Press [▲, ▼] to select the item and press [ENTER].</b></p> <ul style="list-style-type: none"> <li>If “Copy Pictures” is selected Select the still picture you want to add and press [ENTER].</li> <li>If “Copy Album” is selected All the still pictures in the album will be copied.</li> </ul> <p>④ <b>Press [◀, ▶] to select “Yes” or “No” and press [ENTER].</b></p> <ul style="list-style-type: none"> <li>If you want to continue copying, select “Yes” and go to step ②.</li> </ul> <p><b>Only for “Create Album”</b></p> <p>⑤ <b>Press [◀, ▶] to select “Yes” or “No” and press [ENTER].</b></p> <ul style="list-style-type: none"> <li>If “Yes” is selected: You can give names to albums. (→ 56, Entering text)</li> <li>If “No” is selected: The recording date of the first picture in the album becomes the album name. (If there is no recording date information, the date will appear as [--.--.--].)</li> </ul>
<p>Copy to DVD-RAM HDD Copy to HDD RAM</p>	<p><b>Press [◀] to select “Start” and press [ENTER].</b></p> <p>You cannot copy if multiple albums are selected.</p>

\* Multiple editing is possible.

**Note**

- Timer recordings do not start when performing “Add Pictures”, “Create Album”, “Copy to DVD-RAM” or “Copy to HDD”.
- You cannot perform “Add Pictures” or “Create Album” to a higher folder.

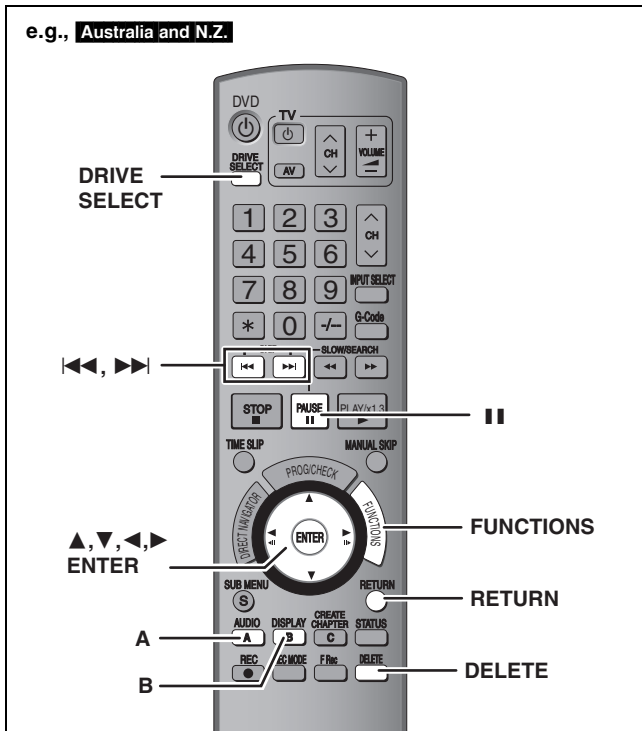

**HDD RAM -R -R DL -RW(V) +R +R DL +RW SD**

(You cannot delete items on finalized discs.)

- A title or a picture cannot be restored once it is deleted. Make certain before proceeding.
- You cannot delete while recording or copying.

### Preparation

- Press [DRIVE SELECT] to select the HDD, DVD or SD drive.
- **RAM SD** Release protection (⇒ 53, Setting the protection).

### Available disc space after deleting

- **HDD RAM SD** If you delete a recorded title (or a still picture), the space deleted becomes available for recording.

Available disc space increases after deleting any of these titles or still pictures

Title	Title	.....	Last title recorded	Available disc space
-------	-------	-------	---------------------	----------------------

- **-RW(V) +RW** Available recording space increases only when the last recorded title is deleted.

Available disc space does not increase even after deleting

Title	Title	.....	Last title recorded	Available disc space
-------	-------	-------	---------------------	----------------------

- **-R -R DL +R +R DL** Available space does not increase even after the contents are deleted.

## Using the DELETE Navigator to delete

- 1 While stopped  
Press [FUNCTIONS].
- 2 Press [**▲**, **▼**] to select “Delete” and press [ENTER].

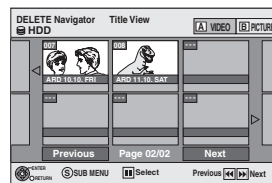

**HDD RAM** To switch to the other view

Press [B] to select “PICTURE”.  
Press [A] to select “VIDEO”.

- 3 If you want to delete a title:  
Press [**▲**, **▼**, **◀**, **▶**] to select the title and press [ENTER].

If you want to delete an album:

Press [**▲**, **▼**, **◀**, **▶**] to select the album and press [DELETE].

If you want to delete a still picture:

- ① Press [**▲**, **▼**, **◀**, **▶**] to select the album that contains the still picture you want to delete and press [ENTER].
- ② Press [**▲**, **▼**, **◀**, **▶**] to select the still picture and press [ENTER].

You can confirm the titles or pictures etc. that you have selected using the sub menu.

- Refer to sub menu operations for the “Title View” (⇒ 38, step 5).
- Refer to sub menu operations for the “Album View” (⇒ 42, step 4).
- Refer to sub menu operations for the “Picture (JPEG) View” (⇒ 42, step 4).

### To show other pages

Press [**◀**, **▶**] to show other pages.

### Multiple editing

Select with [**▲**, **▼**, **◀**, **▶**] and press [II]. (Repeat.)  
A check mark appears. Press [II] again to cancel.

- 4 Press [**◀**] to select “Delete” and press [ENTER].

The title, album or the picture is deleted.

### To return to the previous screen

Press [RETURN].

### To exit the screen

Press [RETURN] several times.

## Deleting titles or pictures during play

- 1 While playing  
Press [DELETE].  
You cannot delete a picture during a Slide Show.
- 2 Press [**◀**, **▶**] to select “Delete” and press [ENTER].  
The title or the picture is deleted.



# Copying titles or playlists

		Copy		Advanced Copy	
<b>Features</b>		Easy copying from HDD to DVD with no difficult settings.		Make a copy list and then copy. You can set the unit to copy titles or playlists in the way you want.	
<b>Copy direction</b>	HDD → DVD	✓		✓	
	DVD → HDD	✗		✓ RAM -RW(VR) +RW DVD-V (Only from a finalized disc)	
<b>High speed mode copy*1</b>		✓		✓ DVD-V You cannot perform high-speed copy with finalized discs. +RW You cannot perform high-speed copy from +RW to HDD.	
<b>Changing recording mode</b>		✗		✓*2	
<b>Finalize*3</b>		-R -R DL -RW(V) +R +R DL Automatically finalized		-R -R DL -RW(V) +R +R DL Can be selected	
		<b>High speed mode</b>	<b>Normal speed mode</b>	<b>High speed mode</b>	<b>Normal speed mode</b>
<b>Copying MPEG2 moving pictures from an SD card (⇒ 49)</b>		✗	✗	✓ HDD RAM only	✗
<b>Copying playlists*4</b>		✗	✗	✓	✓
<b>Are chapters maintained?</b>		✓	✗*5	✓	✗*5
<b>Are thumbnails maintained?</b>		✓	✗*6	✓*7	✗*6
<b>Recording and Playing while Copying</b>		✗	✗	✓*8	✗

\*1 To high speed copy titles (or playlists created from those titles), set "Rec for High Speed Copy" to "On" before recording to the HDD (⇒ 22).

However in the following cases, copying to DVD-R, DVD-R DL, DVD-RW (DVD-Video format), +R, +R DL and +RW using the high speed mode does not work.

- Playlists created from titles using a variety of recording modes
- Playlists created from multiple titles using FR recording mode
- Playlists mixed with a variety of audio types (Dolby Digital and LPCM, etc.)
- Titles that contain many deleted segments
- MPEG2 moving picture titles copied to the HDD from an SD card

• +R +R DL +RW Titles recorded in "EP" mode and "FR (recordings 5 hours or longer)" mode. (Displayed ►►!)

\*2 If you select a recording mode with better picture quality than the original, the picture quality does not improve. (However it does prevent against degradation of picture quality.)

+R DL You cannot copy in EP mode.

\*3 You cannot select "Top Menu" or "Auto-Play Select".

If you want to set auto-play select or the background colour, select "Top Menu" or "Auto-Play Select" in "DVD Management" before copying (⇒ 55).

\*4 You cannot copy playlists with a play time more than 8 hours.

When you copy a playlist, it will become a title in the destination drive.

\*5 RAM -R DL +R DL +RW : One title becomes one chapter.

-R -RW(V) +R : Chapters are created automatically (-R -RW(V) about 5-minutes +R about 8-minutes) when finalizing after copying the disc.

\*6 Thumbnails return to the default position.

\*7 When copying playlists, the thumbnails may not reflect changes made to them.

\*8 Possible only with titles on the HDD

(However it is not possible when copying with automatic finalization or when copying MPEG2 moving pictures from an SD card.)

-You cannot perform chasing play or edit, etc. while copying.

-You cannot play a playlist while copying titles with "One time only recording" restriction (⇒ 8).

-Still pictures cannot be played.

## ■ Approximate copying times (Max. speed)

(excludes time required to write data management information)

HDD		5X Speed DVD-RAM		16X Speed DVD-R		4X Speed DVD-R DL		4X Speed*1 DVD-RW		8X Speed*2 +R		2.4X Speed +R DL		4X Speed +RW	
Rec mode	Rec time	Required time	Speed	Required time	Speed	Required time	Speed	Required time	Speed	Required time	Speed	Required time	Speed	Required time	Speed
XP	1 hour	12 min.	5x	6 min.	10x	15 min.	4x	15 min.	4x	8 min. 35 s.	7x	25 min.	2.4x	15 min.	4x
SP		6 min.	10x	2 min. 25 s.	25x	7 min. 30 s.	8x	7 min. 30 s.	8x	4 min. 10 s.	14x	12 min. 30 s.	4.8x	7 min. 30 s.	8x
LP		3 min.	20x	1 min. 15 s.	48x	3 min. 45 s.	16x	3 min. 45 s.	16x	2 min. 25 s.	25x	6 min. 15 s.	7.2x	3 min. 45 s.	16x
EP (6H)		2 min.	30x	52 sec.	69x	2 min. 30 s.	24x	2 min. 30 s.	24x						
EP (8H)		1 min. 30 s.	40x	42 sec.	86x	1 min. 53 s.	32x	1 min. 53 s.	32x						

• The above values indicate the quickest possible times and speeds to high speed copy a one hour title recorded on the HDD to a high speed recording compatible disc. Depending on what part of the disc is being written to, the features of the disc, etc., the times and speeds will vary.

\*1 In this unit, copying with a 6X Speed DVD-RW disc will be performed at the same speed as with a 4X Speed DVD-RW disc.

\*2 In this unit, copying with a 16X Speed +R disc will be performed at the same speed as with a 8X Speed +R disc.

### Note

• When recording or playing while copying, the unit may not use the maximum recording speed.

• Depending on the condition of the disc, the unit may not copy using the maximum speed.

### Regarding copying to DVD-R DL (single-sided, Dual Layer) and +R DL (single-sided, Double Layer)

When not copying in high speed mode, titles are temporarily copied at normal speed to the HDD and then copied at high speed to DVD-R DL and +R DL. The titles that were temporarily copied to the HDD are then deleted.

You cannot copy to DVD-R DL and +R DL in the following cases.

-When there is not enough free space on the HDD. (When copying to a new blank disc, if you intend to fill a new disc when copying to it, the equivalent of up to 4 hours of free space in SP mode is needed on the HDD.)

-When the number of titles recorded to the HDD and the number of titles to be copied to the DVD-R DL and +R DL is greater than 500 in total.

When playing a title recorded on both layers, video and audio may momentarily cut out when the unit is switching layers. (⇒ 5)

### Regarding copying of digital broadcasts that allow "One time only recording"

You can copy a recorded title to a CPRM (⇒ 73) compatible DVD-RAM, however, the title is deleted from the HDD.

- Titles or playlists cannot be copied from DVD-RAM to the HDD.
- Titles will not be copied if they are protected (⇒ 39).
- You cannot copy playlists created from "One time only recording" titles.
- Titles with recording limitations and playlists cannot be registered on the same copying list.

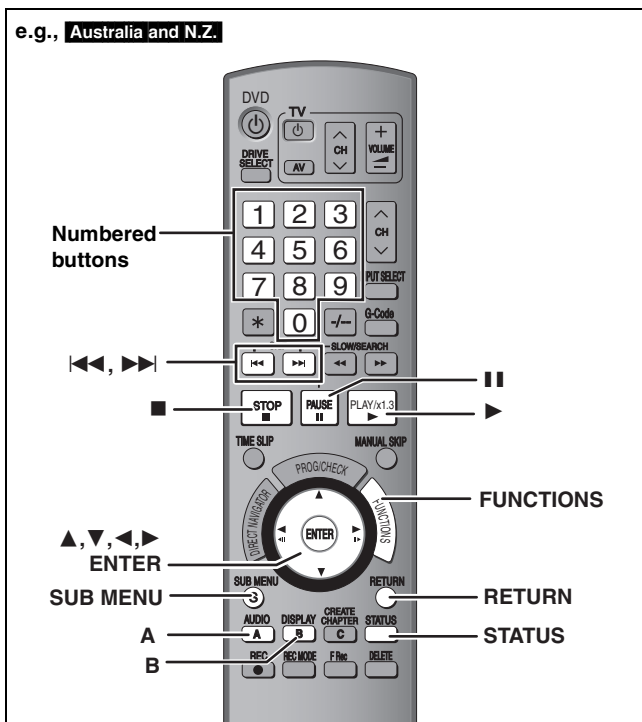

■ **Speed and recording mode when copying**  
**HDD** → **RAM** : High speed  
**HDD** → **-R -R DL -RW(V) +R +R DL +RW** : Refer to the following table.

Rec for High Speed Copy (⇒ 59)	Copy speed
Only titles recorded with "Rec for High Speed Copy" set to "On".	High speed
Only titles recorded with "Rec for High Speed Copy" set to "Off".	Normal speed (Recording mode is FR.)
When making a copy of multiple titles that were recorded with "Rec for High Speed Copy" set to "On" and "Off".	

- **+R +R DL +RW** When making a copy that contains titles recorded in "EP" mode or "FR (recordings 5 hours or longer)" mode (Displayed **▶▶▶**), copy will be performed at normal speed (Recording mode is FR).
- If the copy destination disc space is exceeded, copy will be performed at normal speed (Recording mode is FR).

**Before copying**

**When copying a title with main and secondary audio**  
 ● Select the audio type for recording bilingual broadcast from "Bilingual Audio Selection" (⇒ 60) when:  
 - Copying to a DVD-R, DVD-R DL, DVD-RW (DVD-Video format), +R, +R DL and +RW.  
 - When "Audio Mode for XP Recording" is set to "LPCM" (⇒ 60) and you are copying in XP mode.

**Copying 16:9 aspect titles**  
 The titles are copied in 4:3 aspect if you copy to a DVD-R, DVD-R DL, DVD-RW (DVD-Video format), +R, +R DL or +RW.

**Note**  
 Titles and playlists recorded using a different encoding system (PAL or NTSC) from the TV system currently selected on the unit cannot be copied.

**Preparation**  
 ● Insert a disc that you can use for copying (⇒ 4, 5).  
 ● Confirm that there is enough remaining disc space.

**Copy**

DVD-R, DVD-R DL, DVD-RW (DVD-Video format), +R and +R DL are automatically finalized (⇒ 73). After finalizing, the discs become play-only and you can also play them on other DVD equipment. However, you can no longer record or edit.

**HDD** → **RAM -R -R DL -RW(V) +R +R DL +RW**  
 (You cannot copy to finalized discs.)

**1** While stopped  
 Press **[FUNCTIONS]**.

**2** Press **[▲, ▼]** to select "Copy" and press **[ENTER]**.

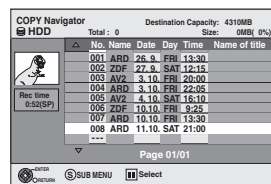

**3** Press **[▲, ▼]** to select the title you want to copy and press **[ENTER]**.

**To show other pages**  
 Press **[◀, ▶]** to show other pages.

**Multiple editing**  
 Select with **[▲, ▼]** and press **[■]**. (Repeat.)  
 Press **[ENTER]** to register.  
 ● A check mark appears. Press **[■]** again to cancel.

**4** After you start copying DVD-R, DVD-R DL, DVD-RW (DVD-Video format), +R and +R DL discs, they become play-only and you can no longer record or edit.  
 Press **[◀, ▶]** to select "Start" and press **[ENTER]**.  
 Copy starts.

**To return to the previous screen**  
 Press **[RETURN]**.

■ **To stop copying** ⇒ 48

■ **COPY Navigator/Copying list icons and functions** ⇒ 48

■ **To check the properties of a title and sort COPY Navigator**

**1** Press **[▲, ▼]** to select the title and press **[SUB MENU]**.

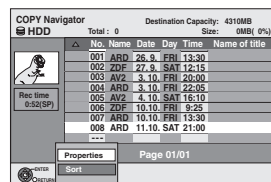

**2** Press **[▲, ▼]** to select "Properties" or "Sort" and press **[ENTER]**.

**Properties:**  
 The name, recording date, channel etc. of the selected title are shown.

**Sort:**  
 Press **[▲, ▼]** to select the item and press **[ENTER]**.  
 This changes the way that titles are displayed. You can select to display titles by No., recording date, day, channel, recording start time and title name. (You cannot select a title if it has a check mark.)  
 If you close the COPY Navigator screen, the display order is cancelled.

**Note**  
 ● When copying titles in high speed mode to 5x high speed recording compatible DVD-RAM or 8x high speed recording compatible DVD-R or +R, the sound of the disc rotating becomes louder than normal.  
 If you want copy to perform more quietly, select "Normal (Silent)" in "DVD Speed for High Speed Copy" in the Setup menu (⇒ 59).  
 ● If you register multiple titles, they are copied in order from the title at the top of the screen and not in the order you registered them. To change the order that titles are copied, create a copying list and then copy the contents of the list (⇒ 47).

## Copying using the copying list— Advanced Copy

HDD ↔ RAM +RW

-RW(VR) → HDD

HDD → -R -R DL -RW(V) +R +R DL

SD → HDD RAM

You can order titles and playlists as desired for copy to disc.

See also the notes “Before copying” (⇒ 46).

- 1 While stopped  
Press [FUNCTIONS].
- 2 Press [▲, ▼] to select “To Others”  
and press [ENTER].
- 3 Press [▲, ▼] to select “Advanced  
Copy” and press [ENTER].

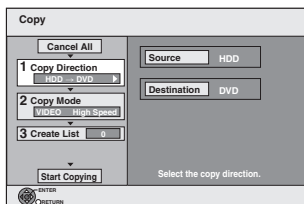

- If you are not going to change the registered list press [▼] several times (⇒ step 7).

## 4 Set the copy direction.

- If you are not going to change the copying direction, press [▼] (⇒ step 5).
- ① Press [▲, ▼] to select “Copy Direction” and press [▶].
  - ② Press [▲, ▼] to select “Source” and press [ENTER].
  - ③ Press [▲, ▼] to select the drive and press [ENTER].
  - ④ Press [▲, ▼] to select “Destination” and press [ENTER].
  - ⑤ Press [▲, ▼] to select the drive and press [ENTER].  
The same drive as the copy source cannot be selected.
  - ⑥ Press [◀] to confirm.

## 5 Set the recording mode.

- If you are not going to change the recording mode, press [▼] (⇒ step 6).
- ① Press [▲, ▼] to select “Copy Mode” and press [▶].
  - ② Press [▲, ▼] to select “Format” and press [ENTER].
  - ③ Press [▲, ▼] to select “VIDEO” and press [ENTER].
  - ④ Press [▲, ▼] to select “Recording Mode” and press [ENTER].
  - ⑤ Press [▲, ▼] to select the mode and press [ENTER].
  - ⑥ Press [◀] to confirm.

## 6 Register titles and playlists for copy.

- If you are going to copy a registered list without making any changes to it (⇒ step 7).
- ① Press [▲, ▼] to select “Create List” and press [▶].

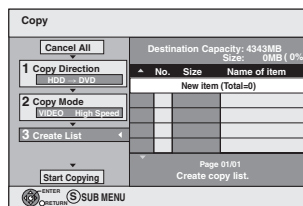

- ② Press [▲, ▼] to select “New item” and press [ENTER].
- ③ Press [A] to select “VIDEO” or press [B] to select “Playlists”.

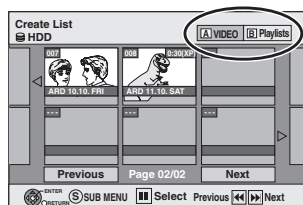

- ④ Press [▲, ▼, ◀, ▶] to select the titles or playlists and press [ENTER].

- When copying to a disc using high speed mode,

**-R -R DL -RW(V)** : only items indicated with “▶▶▶” or “▶▶▶!” can be registered.

**+R +R DL +RW** : only items indicated with “▶▶▶” can be registered.

- To select a multiple number of items together, press [III] to add the check mark and press [ENTER] (⇒ below, Multiple editing).
- To show other pages (⇒ below)
- To edit the copying list (⇒ 48)

You can register a multiple number of titles and playlists on the copying list by repeating steps ②–④.

You cannot start copying when the value of the “Size” (⇒ 48) exceeds 100% (“Destination Capacity” is not sufficient).

- ⑤ Press [◀] to confirm.

## 7 Press [▲, ▼] to select “Start Copying” and press [ENTER].

When copying titles in high speed mode to 5x high speed recording compatible DVD-RAM or 8x high speed recording compatible DVD-R or +R, the sound of the disc rotating becomes louder than normal.

If you want copy to perform more quietly, select “Normal (Silent)” in “DVD Speed for High Speed Copy” in the Setup menu (⇒ 59).

## 8 Press [◀, ▶] to select “Yes” and press [ENTER] to start copying.

HDD → -R -R DL -RW(V) +R +R DL

Press [◀, ▶] to select “Copy & Finalize” or “Copy Only” and press [ENTER].

- If “Copy & Finalize” is selected

After finalizing, the discs become play-only and you can also play them on other DVD equipment. However, you can no longer record or edit.

### To show other pages

Press [▲, ▼, ◀, ▶] to select “Previous” or “Next” and press [ENTER].

- You can also press [◀◀, ▶▶] to show other pages.

### Multiple editing

Select with [▲, ▼, ◀, ▶] and press [III]. (Repeat.)

Press [ENTER] to register to the list.

- A check mark appears. Press [III] again to cancel.

- When you switch between the “VIDEO” and “Playlists” tab, the check mark is cancelled.

(Continued)

Refer to the control reference on page 46.

**To stop copying**

Press and hold [RETURN] for 3 seconds.  
(You cannot stop while finalizing)

**When High-speed copying**

All titles that have completely copied at the point cancelled are copied.

**When Normal Speed copying**

Copies until the point cancelled. However titles with "One time only recording" restriction, only titles that have completely copied at the point cancelled are copied to the disc. Titles that are cancelled before the copy is complete are not copied and remain on the HDD.

- When copying to a DVD-R DL or +R DL only the titles that have completely copied at the point cancelled are copied.

Even if the title was not copied to the DVD-R, DVD-R DL, DVD-RW (DVD-Video format), +R, +R DL or +RW, the amount of remaining writable disc space becomes less.

**To return to the previous screen**

Press [RETURN].

**Recording and playing while copying**

You can record and play using the HDD while high speed copying. (Only when high speed copying without finalizing)

- Still pictures cannot be played.  
Press [ENTER] to cancel the screen display.
- To confirm the current progress  
Press [STATUS].

**Note**

- Timer recordings executed while copying are recorded to the HDD regardless of the recording drive settings.  
(Only when high speed copying without finalizing)

To play DVD-R, DVD-R DL, DVD-RW (DVD-Video format), +R and +R DL on other players, it is necessary to finalize them after copy.

**COPY Navigator/Copying list icons and functions**

COPY Navigator/Copying list indicators



Titles and playlists that can be copied in high speed mode to DVD-R, DVD-R DL, DVD-RW (DVD-Video format), +R, +R DL, +RW (→ 22)



Titles and playlists that can be copied in high speed mode to DVD-R, DVD-R DL, DVD-RW (DVD-Video format) (→ 22)  
(However, titles and playlists cannot be copied in high speed mode to +R, +R DL, +RW)



Title with "One time only recording" restriction (→ 8, When recording digital broadcasts)



Titles deleted from the HDD by "One time only recording" restriction after copying. (→ 8, When recording digital broadcasts)



Title or playlist contains still picture(s)  
•Still picture(s) cannot be copied.

**(NTSC)**

Title or playlist recorded using a different encoding system from that of the TV system currently selected on the unit.

**(PAL)**

•Titles and playlists displaying these marks cannot be selected.

Data size of each registered item

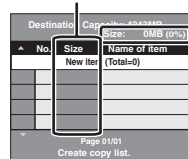

**Size:**

Data size recorded to the copy destination

- When copying at normal speed, the total data size will change according to the recording mode.
- The total data size shown may be larger than the sum of the data sizes for each registered item, because of data management information being written to the copy destination, etc.

**To edit the copying list**

Select the item in step 6-4 (→ 47, right column)

- 1 Press [SUB MENU].
- 2 Press [▲, ▼] to select the operation and press [ENTER].

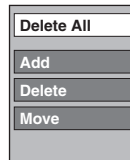

**Delete All:**

Delete all items registered on the copying list.  
Press [◀, ▶] to select "Yes" and press [ENTER].

**Add:**

Add new items to the copying list.  
Press [▲, ▼, ◀, ▶] to select the playlists and titles to be added and press [ENTER].

**Delete:**

Delete the selected items.  
Press [◀, ▶] to select "Yes" and press [ENTER].  
You can also delete multiple items (→ 47, Multiple editing).

**Move:**

Move selected items or change the order of items on the copying list.  
Press [▲, ▼] to select the destination and press [ENTER].

**To cancel all registered copying setting and lists**

After performing steps 1-3 (→ 47, left column)

- 1 Press [▲, ▼] to select "Cancel All" and press [ENTER].
  - 2 Press [◀, ▶] to select "Yes" and press [ENTER].
- The settings and lists may be cancelled in the following situations.
    - When a title, still picture, etc. has been recorded or deleted at the copy source
    - When steps have been taken, for instance, to turn off the unit, open the tray, change the copy direction, etc.

## Copying a finalized DVD-R, DVD-R DL, DVD-RW (DVD-Video format), +R and +R DL

DVD-V → HDD

You can copy the content of finalized DVD-R, DVD-R DL, DVD-RW (DVD-Video format), +R, and +R DL to the HDD and re-edit. While playing a disc, the content being played is copied to the HDD according to the set time.

- If you perform search, frame-by-frame or pause while copying, that portion of title is not recorded.

### • Operations and on screen displays during copy are also recorded.

- Almost all DVD-Video on sale have been treated to prevent illegal copying, and cannot be copied.
- The following cannot be copied: DVD-Audio, Video CD, Audio CD and so on.

### Preparation

- Insert the finalized disc (⇒ 28).

After performing steps 1–5 (“Format” is automatically set to “DVD-Video”) (⇒ 47, Copying using the copying list–Advanced Copy)

## 6 Set “Copy Time”.

- If you are not going to change the setting (⇒ step 7).

### ■ Setting the unit to copy according to the set time

- 1 Press [▲, ▼] to select “Copy Time” and press [▶].
  - 2 Press [▲, ▼] to select “Time Setting” and press [ENTER].
- Setting the unit to copy all the content on the disc
    - 3 Press [▲, ▼] to select “Off” and press [ENTER].
    - 4 Press [◀] to confirm.

Copy will continue until there is not enough available recording space on the HDD.

### • Setting the copying time

- 3 Press [▲, ▼] to select “On” and press [ENTER].
- 4 Press [▲, ▼] to select “Copy Time” and press [ENTER].

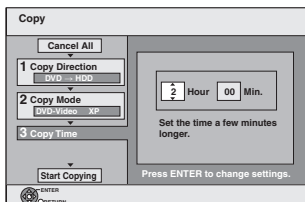

- 5 Press [◀, ▶] to select “Hour” and “Min.” and press [▲, ▼] to set the recording time.
- 6 Press [ENTER].
- 7 Press [◀] to confirm.

Copying to the HDD continues for the set time even after the content being played finishes.

- Set a few minutes longer than the source title, in order to include the operation time before play begins.
- You can also set the recording time with the numbered buttons.

## 7 Press [▲, ▼] to select “Start Copying” and press [ENTER].

Press [◀, ▶] to select “Yes” and press [ENTER] to start copying.

The disc top menu is displayed.

- Disc play automatically begins from title 1 when “Title 1” is selected from the “Auto-Play Select” menu when finalizing the disc (⇒ 55).

## 8 When the top menu is displayed

Press [▲, ▼, ◀, ▶] to select the title you want to start copying, and press [ENTER].

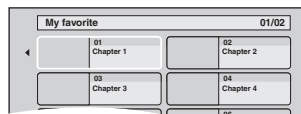

While playing in order, all the titles after the selected title are recorded until the set time. (After the last title on the disc has finished playing the top menu is recorded until the set time is reached.)

### To return to the previous screen

Press [RETURN].

### To stop copying

Press [■].

You can also press and hold [RETURN] for 3 seconds to stop copying.

- If stopped partway, copying will be up to that point.

### Note

- The screen saver on the right is recorded at the beginning.
- The content is recorded as 1 title from the start of copy to the end.
- If play does not begin automatically or if the top menu does not display automatically, press [▶] (PLAY) to start.
- Even if you copy a high quality video/audio DVD, the original picture and audio quality cannot be exactly replicated.
- If you want to copy a title from a finalized DVD-RW (DVD Video Recording format), create a copy list and then copy (⇒ 47, Copying using the copying list–Advanced Copy).



## Copying MPEG2 moving pictures from an SD card

Motion pictures encoded in the MPEG2 format, which have been taken by a Panasonic SD Video Camera, digital video camera etc, can be stored on HDD or DVD-RAM.

(All the recordings on the same date become a title.)

- You cannot playback MPEG2 moving pictures on an SD card with this unit.

You must copy the files to the HDD or a DVD-RAM.

- You cannot playback or record while copying MPEG2.

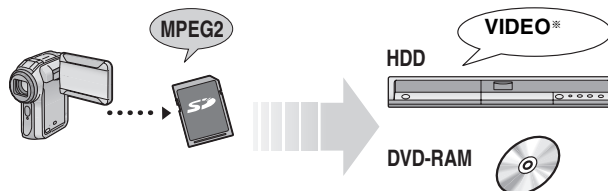

\* Conventionally recorded programmes

The display below automatically appears when you insert a card into the SD card slot while stopped. Press [▲, ▼] to select “Copy Video (MPEG2)” and press [ENTER]. Then go to step 7 on page 47.

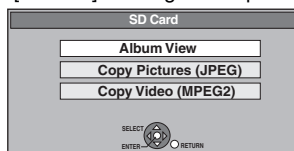

### How to copy

Refer to “Copying using the copying list–Advanced Copy” (⇒ 47) Please set the items in step 4 and 5 as shown below.

### Copy Direction:

Source : SD CARD

### Copy Mode:

Format : VIDEO

- MPEG2 moving pictures on an SD card are automatically registered on the copy list.
- If there are no MPEG2 moving pictures on an SD card, “Copy Video (MPEG2)” is not displayed.



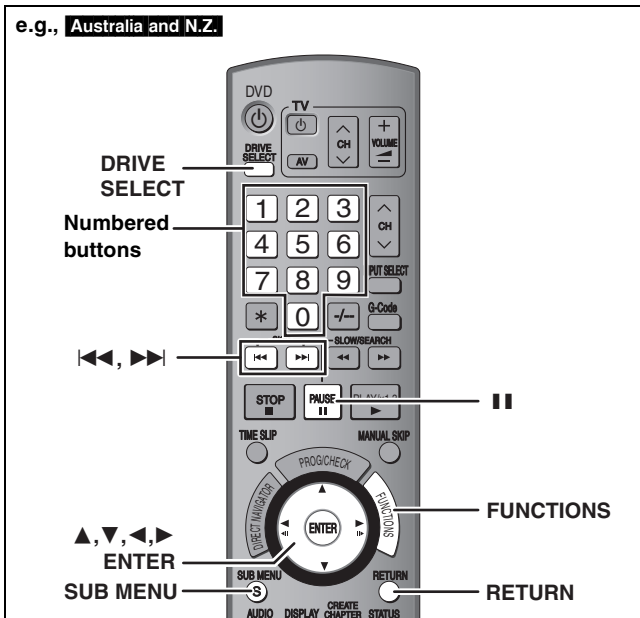

**HDD RAM SD**  
 • You can use SD Memory Cards with capacities from 8 MB to 2 GB (⇒ 7).  
 • You cannot copy pictures recorded to CD-R/CD-RW.

**SD**  
 While stopped put the card in the slot, and the menu (⇒ below) is automatically displayed.  
 Press [▲, ▼] to select “Copy Pictures (JPEG)”, press [ENTER] and then go to step 4 on page 51, “Copying all the still pictures on a card—Copy All Pictures”.

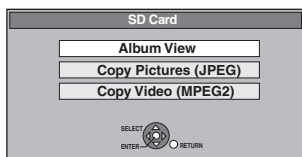

Press [RETURN] to exit the screen.

## Copying using the copying list

- 1 While stopped  
Press [FUNCTIONS].
- 2 Press [▲, ▼] to select “To Others” and press [ENTER].
- 3 Press [▲, ▼] to select “Advanced Copy” and press [ENTER].

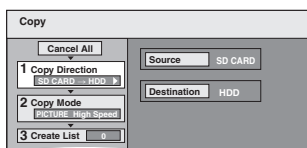

- If you are not going to change the registered list press [▼] several times (⇒ step 7).
- 4 Set the copy direction.  
 • If you are not going to change the copying direction, press [▼] (⇒ step 5).  
 ① Press [▲, ▼] to select “Copy Direction” and press [▶].  
 ② Press [▲, ▼] to select “Source” and press [ENTER].  
 ③ Press [▲, ▼] to select the drive and press [ENTER].  
 ④ Press [▲, ▼] to select “Destination” and press [ENTER].  
 ⑤ Press [▲, ▼] to select the drive and press [ENTER].  
 The same drive as the copy source can be selected.  
 ⑥ Press [◀] to confirm.

- 5 Set the recording mode.  
 • If you are not going to change the recording mode, press [▼] (⇒ step 6).  
 ① Press [▲, ▼] to select “Copy Mode” and press [▶].  
 ② Press [▲, ▼] to select “Format” and press [ENTER].  
 ③ Press [▲, ▼] to select “PICTURE” and press [ENTER].  
 “Recording Mode” is automatically set to “High Speed”.  
 ④ Press [◀] to confirm.

## 6 Register still pictures for copy.

- If you are going to copy a registered list without making any changes to it (⇒ step 7).

You can register still pictures or still picture folders.

- Still pictures and folders cannot be registered on the same list.

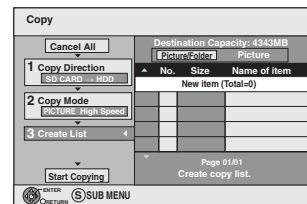

### ■ To register individual still pictures

- ① Press [▲, ▼] to select “Create List” and press [▶].
- ② Press [▲, ▼] to select “New item” and press [ENTER].
- ③ Press [▲, ▼, ◀, ▶] to select the still picture and press [ENTER].

- To select a multiple number of items together, press [II] to add the check mark and press [ENTER] (⇒ 51, Multiple editing).
- To show other pages (⇒ 51)
- To select the still pictures in another folder (⇒ 51)
- To edit the copying list (⇒ 51)

You can register a multiple number of still pictures on the copying list by repeating steps ②–③.

- ④ Press [◀] to confirm.

### ■ To register on a folder by folder basis

- ① Press [▲, ▼] to select “Create List” and press [▶].
- ② Press [▲, ▼] to select “Picture/Folder” and press [ENTER].

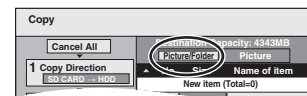

- ③ Press [▲, ▼] to select “Folder” and press [ENTER].
- ④ Press [▲, ▼] to select “New item” and press [ENTER].
- ⑤ Press [▲, ▼] to select the folder and press [ENTER].

- To select a multiple number of items together, press [II] to add the check mark and press [ENTER] (⇒ 51, Multiple editing).
- To show other pages (⇒ 51)
- To switch to another higher folder (⇒ 51)
- To edit the copying list (⇒ 51)

You can register a multiple number of folders on the copying list by repeating steps ④–⑤.

- ⑥ Press [◀] to confirm.

## 7 Press [▲, ▼] to select “Start Copying” and press [ENTER].

- For individual still pictures only  
 When specifying another folder as the copying destination, select “Folder”.

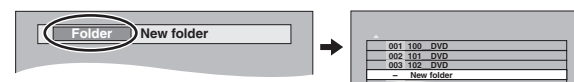

## 8 Press [◀, ▶] to select “Yes” and press [ENTER] to start copying.

### To stop copying

Press and hold [RETURN] for 3 seconds.

### To return to the previous screen

Press [RETURN].



### To show other pages

Press [▲, ▼, ◀, ▶] to select “Previous” or “Next” and press [ENTER].

• You can also press [◀◀, ▶▶] to show other pages.

### Multiple editing

Select with [▲, ▼, ◀, ▶] and press [III]. (Repeat.)

Press [ENTER] to register to the list.

• A check mark appears. Press [III] again to cancel.

### To edit the copying list

Select the item in step 6–③ (for a still picture) or 6–⑤ (for a folder) (⇒ 50, right column)

1 Press [SUB MENU].

2 Press [▲, ▼] to select the operation and press [ENTER].

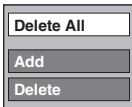

#### Delete All:

Delete all items registered on the copying list.

Press [◀, ▶] to select “Yes” and press [ENTER].

#### Add:

Add new items to the copying list.

Press [▲, ▼, ◀, ▶] to select the still picture or folder to be added and press [ENTER].

#### Delete:

Delete the selected items.

Press [◀, ▶] to select “Yes” and press [ENTER].

You can also delete multiple items (⇒ above, Multiple editing).

### To cancel all registered copying settings and lists

After performing steps 1–3 (⇒ 50)

1 Press [▲, ▼] to select “Cancel All” and press [ENTER].

2 Press [◀, ▶] to select “Yes” and press [ENTER].

• The settings and lists may be cancelled in the following situations.

–When a title or still picture has been recorded or deleted at the copy source

–When steps have been taken, for instance, to turn off the unit, remove the card, open the tray, change the copy direction, etc.

### To select another folder

(⇒ 7, Structure of folders displayed by this unit)

① Press [▲, ▼, ◀, ▶] to select “Folder” and press [ENTER].

If you want to switch to another higher folder (⇒ below).

② Press [▲, ▼] to select the folder and press [ENTER].

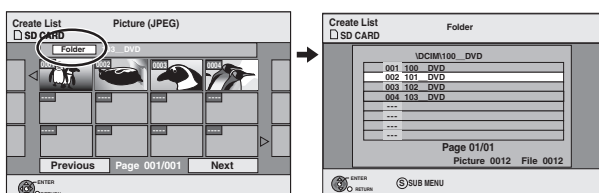

You can also select folders with the numbered buttons.

e.g., 5: [0] ⇒ [0] ⇒ [5]

15: [0] ⇒ [1] ⇒ [5]

115: [1] ⇒ [1] ⇒ [5]

• The still pictures of different folders cannot be registered on the same list.

### To switch to another higher folder

• Only when selecting the source folder

If there is a multiple number of higher folders recognizable, while the screen on the right appears

1 Press [SUB MENU] and press [ENTER].

2 Press [◀, ▶] to select the higher folder and press [ENTER].

You cannot register a folder with a different higher folder to the same list.

3 Press [▲, ▼] to select the desired folder and press [ENTER].

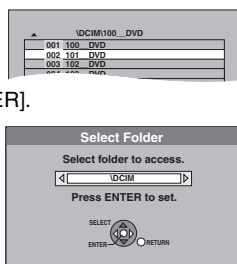

## Copying all the still pictures on a card— Copy All Pictures

SD → HDD or RAM

### Preparation

Press [DRIVE SELECT] to select the SD drive.

- 1 While stopped  
Press [FUNCTIONS].
- 2 Press [▲, ▼] to select “To Others” and press [ENTER].
- 3 Press [▲, ▼] to select “Copy All Pictures” and press [ENTER].

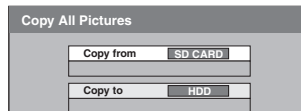

- 4 Press [▲, ▼] to select “Copy to” and press [◀, ▶] to select the drive.
- 5 Press [▲, ▼, ◀, ▶] to select “Copy” and press [ENTER].

### To stop copying

Press and hold [RETURN] for 3 seconds.

### To return to the previous screen

Press [RETURN].

### Note

- When copying the still pictures on a folder by folder basis (⇒ 50) or card by card basis (⇒ above, Copy All Pictures), files other than the still picture files inside the folder will also be copied. (This does not apply to the lower folders contained inside the folders.)
- If still pictures are already contained inside the copy destination folder, the new still pictures are recorded following the existing still pictures.
- If the space on the destination drive runs out or the number of files/folders to be copied exceeds the maximum (⇒ 31), copying will stop partway through.
- When a name has not been input for the copy source folder, it is possible that this folder's name will not be the same on the copy destination. It is recommended that you input a folder name before copying (⇒ 43, Enter Album Name).
- You cannot copy the information about the print number setting (DPOF) or the picture rotation.
- The sequence in which the still pictures are registered on the copy list may not be the same at the copy destination.

# Copying from a video cassette recorder

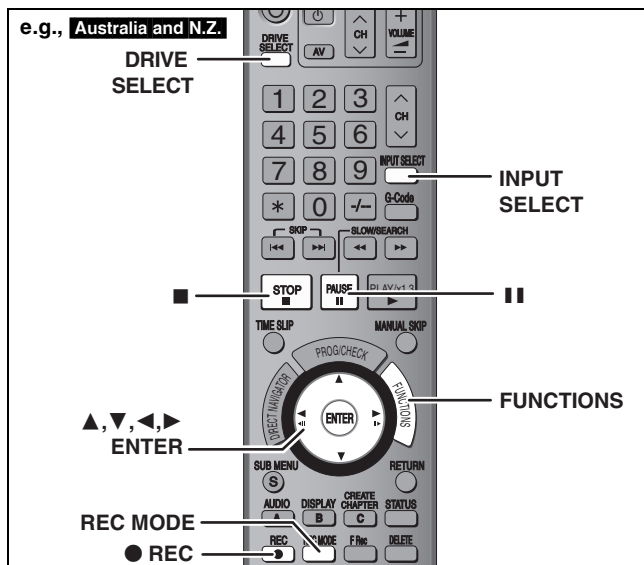

e.g., **Connecting to the AV3 or DV input terminals on the front**  
You can also connect to the AV4 input terminals on the rear.

- Turn off the unit and other video equipment before connecting.

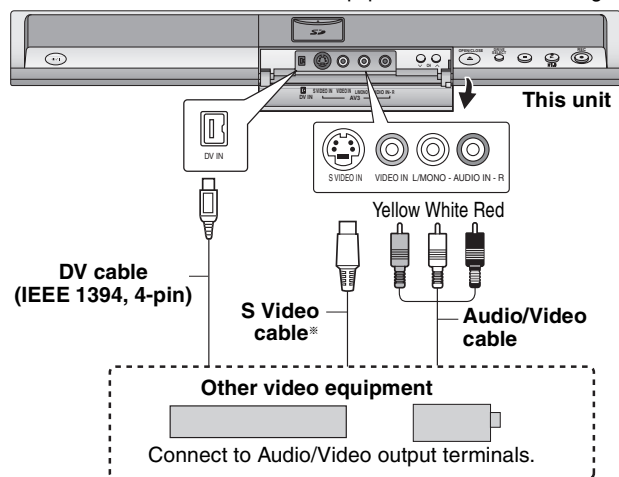

If the audio output of the other equipment is monaural  
Connect to L/MONO on the AV3 input terminals at the front.  
\* The S VIDEO terminal achieves a more vivid picture than the VIDEO terminal.

**When recording from the unit's DV terminal**  
Select the type of audio recording from "Audio Mode for DV Input" in the Setup menu (⇒ 60).  
When recording from DV equipment (e.g., digital video camcorder), you can record audio/video recordings from DV tape only.

**Note**

If it becomes time for a timer recording to start while copying, the recording will start and the copying will stop.

## Manual recording

**HDD RAM -R -RW(V) +R +RW**

**Preparation**

- Press [DRIVE SELECT] to select the HDD or DVD drive.
- Press [REC MODE] to select the recording mode.
- When recording bilingual programmes (⇒ 8, Important notes for recording)
- When the output signal from the external equipment is NTSC, change the "TV System" to "NTSC" in the Setup menu (⇒ 63). This unit cannot record to discs containing both PAL and NTSC signals. (However, both types of programmes can be recorded onto the HDD.)
- To reduce noise in input from a video cassette recorder, set "AV-in NR" to "On" in the on-screen menu (⇒ 37).
- Check the time on the unit is correct.

**1 While stopped**

**Press [INPUT SELECT] to select the input channel for the equipment you have connected.**

e.g., If you have connected to AV3 input terminals, select "AV3".

**2 Start play on the other equipment.**

**3 When you want to start recording**

**Press [● REC].**

Recording starts.

**To skip unwanted parts**

Press [■] to pause recording. (Press again to restart recording.)

**To stop recording**

Press [■].

**Almost all videos and DVD-Video on sale have been treated to prevent illegal copying. Any software that has been so treated cannot be recorded using this unit.**

- Using Flexible Recording (⇒ 23), you can record the content of a video cassette (approx. 1–8 hours) to a 4.7 GB disc with the best possible quality of recording without wasting disc space.

## DV automatic recording (DV Auto Rec)

**HDD RAM -R -RW(V) +R +RW**

**HDD RAM** When the "DV Auto Rec" function is used, programmes are recorded as a title while at the same time chapters are created at each break in the images and the play list is created automatically.

**Preparation**

- 1 Turn off the main unit and DV equipment, then connect the equipment with the unit's DV input terminal (⇒ left column).
  - 2 Turn on the main unit and DV equipment.
  - 3 Press [REC MODE] to select the recording mode.
  - 4 Pause play of the DV equipment at the point you want recording to start.
- When the output signal from the external equipment is NTSC, change the "TV System" to "NTSC" in the Setup menu (⇒ 63).

After preparation is completed, the following screen appears.

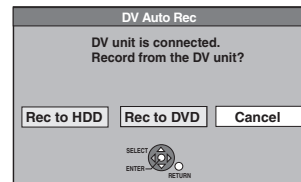

Press [◀, ▶] to select "Rec to HDD" or "Rec to DVD" and press [ENTER].

You can proceed to step 4.

- When the screen is not displayed, press [DRIVE SELECT] to select HDD or DVD and then continue from step 1.

**1 While stopped**

**Press [FUNCTIONS].**

**2 Press [▲, ▼] to select "To Others" and press [ENTER].**

**3 Press [▲, ▼] to select "DV Auto Rec" and press [ENTER].**

**4 Press [◀, ▶] to select "Rec" and press [ENTER].**

Recording starts.

**When recording finishes**

The confirmation screen appears. Press [ENTER] to finish DV automatic recording.

**To stop recording**

Press [■].

**Note**

- Only one piece of DV equipment (e.g., digital video camcorder) can be connected to the unit via the DV input terminal.
- It is not possible to operate the unit from the connected DV equipment.
- The DV input on this unit is for use with DV equipment only. (It cannot be connected to a computer, etc.)
- The DV equipment name may not be shown correctly.
- Depending on the DV equipment, the images or audio may not be input properly.
- The date and time information on the tape of the DV equipment will not be recorded.
- You cannot record and play simultaneously.

If the DV automatic recording function does not work properly, check the connections and DV equipment settings, and turn the unit off and back on.

**If that does not work, follow the instructions for manual recording (⇒ left column).**

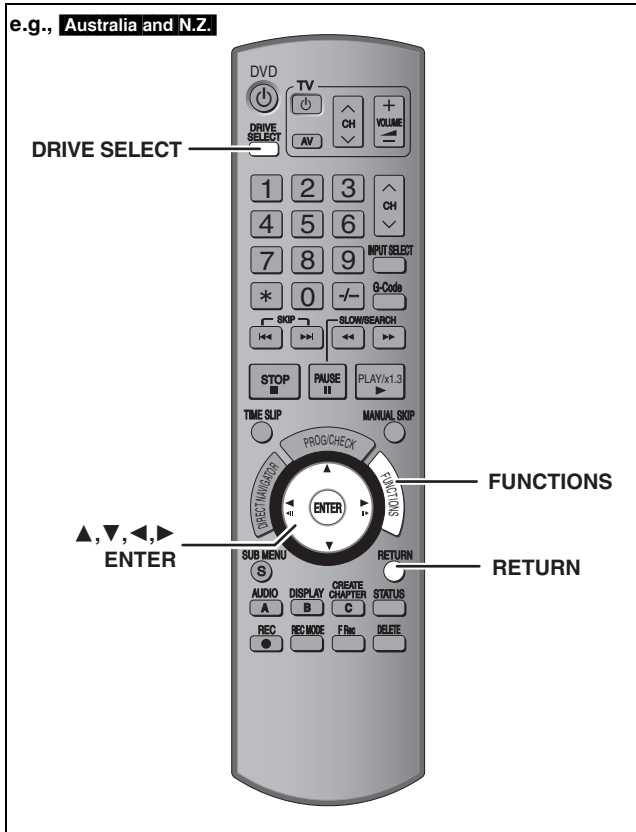

e.g., **Australia and N.Z.**

**HDD RAM -R -R DL -RW(V) +R +R DL +RW -RW(VR) SD**

• You can use SD Memory Cards with capacities from 8 MB to 2 GB (→ 7).

## Common procedures

- 1 While stopped  
Press [FUNCTIONS].
- 2 Press [▲, ▼] to select “To Others” and press [ENTER].

e.g., **Australia and N.Z.**

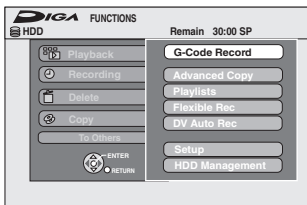

- 3 Press [▲, ▼] to select “HDD Management”, “DVD Management” or “Card Management” and press [ENTER].

e.g., **RAM**

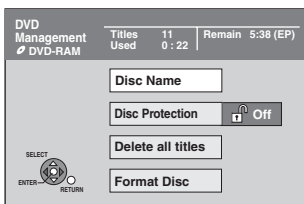

- When HDD has been selected, “Delete all titles” and “Format HDD” are displayed.
- When SD has been selected, “Format Card” only is displayed.

## Setting the protection

**RAM**

### Preparation

- Press [DRIVE SELECT] to select the DVD drive.

After performing steps 1–3 (→ left)

- 4 Press [▲, ▼] to select “Disc Protection” and press [ENTER].
- 5 Press [◀, ▶] to select “Yes” and press [ENTER].

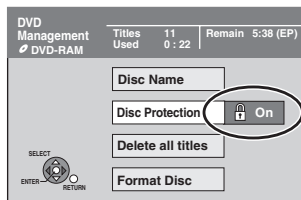

The lock symbol appears closed when the disc is write-protected.

### To return to the previous screen

Press [RETURN].

### To exit the screen

Press [RETURN] several times.

## Cartridge-protection

### For a DVD-RAM with a cartridge

- With the write-protect tab in the protect position, play automatically starts when inserted in the unit.



**SD**

Switch the write-protect switch to the “LOCK” position.



## Providing a name for a disc

**RAM -R -R DL -RW(V) +R +R DL +RW**

You can provide a name for each disc.

### Preparation

- Press [DRIVE SELECT] to select the DVD drive.
- **RAM** Release protection (→ above).

After performing steps 1–3 (→ left)

- 4 Press [▲, ▼] to select “Disc Name” and press [ENTER].

→ 56, Entering text

- The disc name is displayed in the DVD Management window.
- **-R -R DL -RW(V) +R +R DL** With a finalized disc, the name is displayed on the Top Menu.
- **+RW** The disc name is displayed only if you play the disc on other equipment.



### To return to the previous screen

Press [RETURN].

### To exit the screen

Press [RETURN] several times.

Refer to the control reference on page 53.

## Deleting all titles and playlists—Delete all titles

**HDD** **RAM**

### Preparation

- Press [DRIVE SELECT] to select the HDD or DVD drive.
- Release protection (⇒ 53).

After performing steps 1–3 (⇒ 53)

- 4 Press [**▲**, **▼**] to select “Delete all titles” and press [ENTER].
- 5 Press [**◀**, **▶**] to select “Yes” and press [ENTER].
- 6 Press [**◀**, **▶**] to select “Start” and press [ENTER].  
A message appears when finished.
- 7 Press [ENTER].

### To return to the previous screen

Press [RETURN].

### To exit the screen

Press [RETURN] several times.

### Note

- Once deleted, the recorded contents are lost and cannot be restored. Make certain before proceeding.
- Deleting all video titles will result in all playlists also being deleted.
- Still picture data (JPEG, TIFF) or computer data cannot be deleted.
- Delete does not work if one or more titles are protected.

## Deleting all the contents of a disc or card—Format

**HDD** **RAM** **-RW(V)** **+RW** **-RW(VR)** **SD**

**+R** **+R DL** (New disc only)

### Preparation

- Press [DRIVE SELECT] to select the HDD, DVD or SD drive.
- Release protection (⇒ 53).

### Note

Formatting deletes all contents (including computer data), and they cannot be restored. Check carefully before proceeding. The contents are deleted when you format a disc or card even if you have set protection.

After performing steps 1–3 (⇒ 53)

- 4 Press [**▲**, **▼**] to select “Format HDD”, “Format Disc” or “Format Card” and press [ENTER].
- 5 Press [**◀**, **▶**] to select “Yes” and press [ENTER].
- 6 Press [**◀**, **▶**] to select “Start” and press [ENTER].  
A message appears when formatting is finished.
- 7 Press [ENTER].

### Note

- Formatting normally takes a few minutes; however, it may take up to a maximum of 70 minutes (**RAM**).
- Do not disconnect the AC mains lead while formatting. This can render the disc or the card unusable.

### Note

- When a disc or card has been formatted using this unit, it may not be possible to use it on any other equipment.
- **-R** **-R DL** **CD** Formatting cannot be performed on the disc.
- You can format DVD-RW only as DVD-Video format on this unit.

### To stop formatting **RAM**

Press [RETURN].

- You can cancel formatting if it takes more than 2 minutes. The disc must be reformatted if you do this.

### To return to the previous screen

Press [RETURN].

### To exit the screen

Press [RETURN] several times.

## Selecting the background style—Top Menu

**-R -R DL -RW(V) +R +R DL +RW**

You can select the background that will be displayed as the DVD-Video top menu after finalizing.

### Preparation

Press [DRIVE SELECT] to select the DVD drive.

After performing steps 1–3 (⇒ 53)

**4 Press [▲, ▼] to select “Top Menu” and press [ENTER].**

**5 Press [▲, ▼, ◀, ▶] to select the background and press [ENTER].**

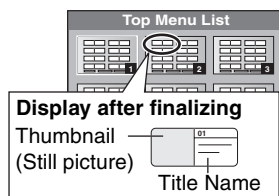

- You can change thumbnails displayed in the top menu. (⇒ 39, Change Thumbnail)

## Selecting whether to show the Top Menu first—Auto-Play Select

**-R -R DL -RW(V) +R +R DL +RW**

You can select whether to show the top menu after finalizing.

### Preparation

Press [DRIVE SELECT] to select the DVD drive.

After performing steps 1–3 (⇒ 53)

**4 Press [▲, ▼] to select “Auto-Play Select” and press [ENTER].**

**5 Press [▲, ▼] to select “Top Menu” or “Title 1” and press [ENTER].**

Top Menu: The top menu appears first.

Title 1: The disc content is played without displaying the top menu.

## Enabling discs to be played on other equipment—Finalize

**-R -R DL -RW(V) +R +R DL**

Make selections from “Top Menu” and “Auto-Play Select” (⇒ above) before finalizing the disc.

### Preparation

Press [DRIVE SELECT] to select the DVD drive.

After performing steps 1–3 (⇒ 53)

**4 Press [▲, ▼] to select “Finalize” and press [ENTER].**

**5 Press [◀, ▶] to select “Yes” and press [ENTER].**

**6 Press [◀, ▶] to select “Start” and press [ENTER].**

A message appears when finalizing is finished.

### Note

- You cannot cancel finalizing.
- Finalizing takes up to 15 minutes.  
(**-R DL +R DL** Finalizing takes up to 60 minutes.)
- Do not disconnect the AC mains lead while finalizing.  
This will render the disc unusable.

**7 Press [ENTER].**

To return to the previous screen

Press [RETURN].

To exit the screen

Press [RETURN] several times.

### Note

When finalizing a high-speed recording compatible disc, it may take longer than displayed on the confirmation screen (approximately four times).

### After finalizing

- R -R DL +R +R DL** The disc becomes play-only and you can no longer record or edit.
- RW(V)** You can record and edit the disc after formatting (⇒ 54) although it becomes play-only after finalizing.
- When copying in high speed, chapters will be replicated.
- R -RW(V)** Titles are divided into about 5-minute (**+R** 8-minute)\* chapters, if
  - the titles were directly recorded to the disc.
  - the titles were copied using any mode other than the high speed mode (excluding **-R DL +R DL**).
- \* This time varies greatly depending on the condition and mode of recording.
- There is a pause of several seconds between titles and chapters during play.

	Before finalizing	After finalizing
Recording/Editing/Entering name	✓	×
Play on other players	×	✓

- You cannot finalize discs recorded on other manufacturer's equipment.
- If you finalize discs recorded on Panasonic equipment other than this unit, the background selected as “Top Menu” may not be displayed.
- Discs finalized on this unit may not be playable on other players due to the condition of the recording.

## Creating Top Menu—Create Top Menu

**+RW**

+RW discs contain no Top Menu data. Top Menu is a convenient function. We recommend you create the menu before playing a +RW disc on other equipment.

**You cannot use the Top Menu for playing on this unit.**

Make selections from “Top Menu” and “Auto-Play Select” (⇒ left column) before creating top menu.

### Preparation

Press [DRIVE SELECT] to select the DVD drive.

After performing steps 1–3 (⇒ 53)

**4 Press [▲, ▼] to select “Create Top Menu” and press [ENTER].**

**5 Press [◀, ▶] to select “Yes” and press [ENTER].**

**6 Press [◀, ▶] to select “Start” and press [ENTER].**

Creating Top Menu starts. You cannot cancel creating. Creating Top Menu can take a few minutes.

**7 Press [ENTER].**

### Note

- You can record or edit discs after creating the Top Menu. But the created menu is deleted when you record or edit disc. In such cases, create the Top Menu again by using “Create Top Menu”.

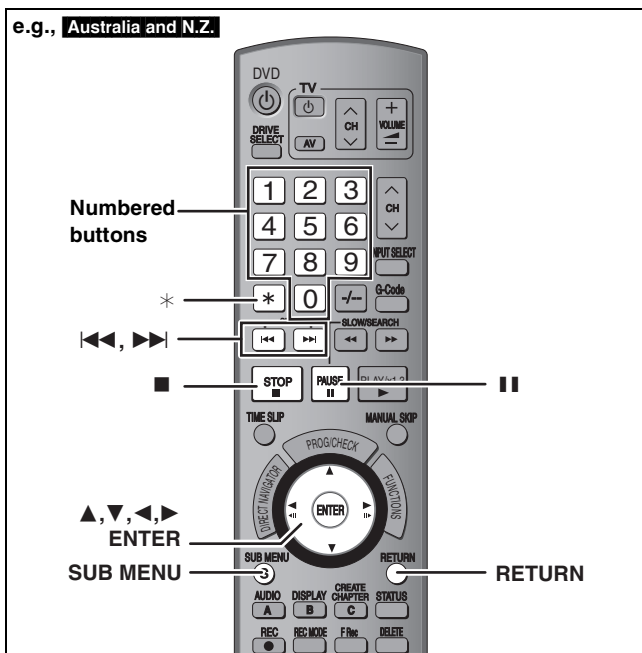

**HDD RAM -R -R DL -RW(V) +R +R DL +RW SD**

You can give names to recorded titles, etc.  
The maximum number of characters:

<b>HDD RAM</b>	Characters
Title	64 (44*)
Playlist	64
Album of still pictures	36
Disc ( <b>RAM</b> )	64
* Title name for timer recording	
<b>-R -R DL -RW(V) +R +R DL +RW</b>	Characters
Title	44
Disc	40
<b>SD</b>	Characters
Album of still pictures	36

### Note

If a name is long, parts of it may not be shown in some screens.

## 1 Show Enter Name screen.

### Title (timer recording)

Select "Programme Name" in step 3 on page 25.

### Title

Select "Enter Name" in step 5 on page 38.

### Playlist

Select "Enter Name" in step 5 on page 41.

### Disc

Select "Disc Name" in step 4 of "Providing a name for a disc" on page 53.

### Album of still pictures

Select "Enter Album Name" in step 4 on page 42, "To edit the album".

**Name field:** shows the text you have entered

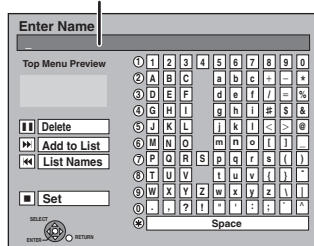

## 2 Press [▲, ▼, ◀, ▶] to select a character and press [ENTER].

Repeat this step to enter other characters.

### •To delete a character

Press [▲, ▼, ◀, ▶] to select the character in the name field and press [■]. (The selected characters are deleted.)

### •Using the numbered buttons to enter characters

e.g., entering the letter "R"

① Press [7] to move to the 7th row.

② Press [7] twice to highlight "R".

③ Press [ENTER].

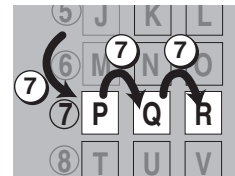

### •To enter a space

Press [\*] and press [ENTER].

### •Add/recall names (⇒ below)

## 3 Press [■] (Set).

"Writing..." appears then the screen returns to the Title view screen and so on.

### To end partway

Press [RETURN].

Text is not added.

### ■ To add a name

You can add frequently used names and recall them later.

Maximum number of added names: 20

Maximum number of characters per name: 20

After entering the name (steps 1–2).

1 Press [▲, ▼, ◀, ▶] to select "Add to List" and press [ENTER].

•You can also press [▶▶] to select "Add to List".

2 Press [◀, ▶] to select "Add" and press [ENTER].

•Press [RETURN] to cancel.

### ■ To recall an added name

1 Press [▲, ▼, ◀, ▶] to select "List Names" and press [ENTER].

•You can also press [◀◀] to select "List Names".

2 Press [▲, ▼, ◀, ▶] to select the name to be recalled and press [ENTER].

### ■ To delete an added name

1 Press [▲, ▼, ◀, ▶] to select "List Names" and press [ENTER].

•You can also press [◀◀] to select "List Names".

2 Press [▲, ▼, ◀, ▶] to select the name to be deleted.

3 Press [SUB MENU] to show "Delete Name" and press [ENTER].

4 Press [◀, ▶] to select "Delete" and press [ENTER].

5 Press [RETURN].

### For your reference

If you enter a long name, only part of it is shown in the Top Menu after finalization (⇒ 55). When entering a title name, the name that will appear in the Top Menu can be previewed in "Top Menu Preview" window.





# FUNCTIONS window

e.g., **Australia and N.Z.**

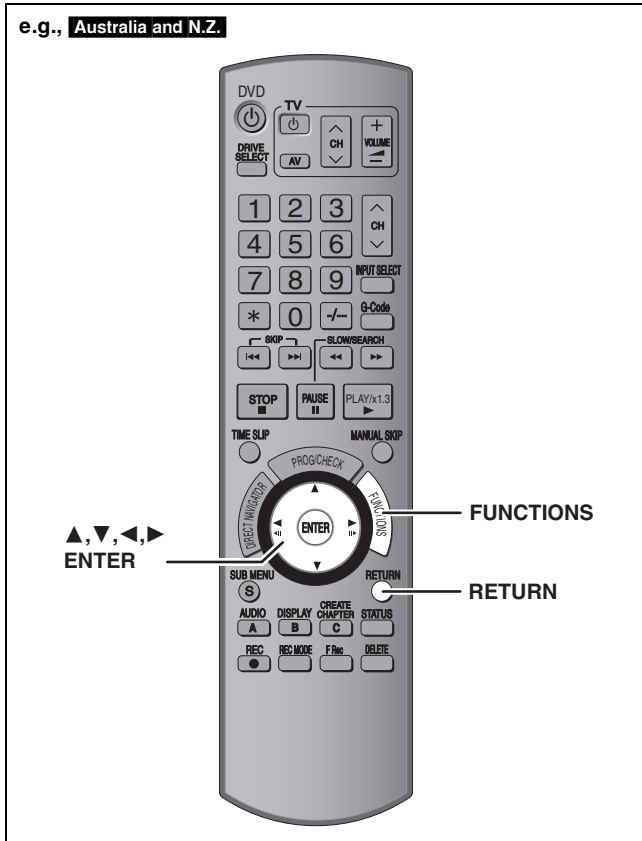

By using the FUNCTIONS window you may access the main functions quickly and easily.

## 1 While stopped

### Press [FUNCTIONS].

Functions displayed depend on the selected drive or type of disc.

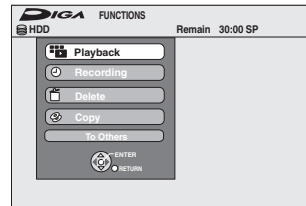

## 2 Press [▲, ▼] to select an item and press [ENTER].

• If you select “To Others” and press [ENTER], the following screen appears. Press [▲, ▼] to select an item and press [ENTER].

e.g., **Australia and N.Z.**

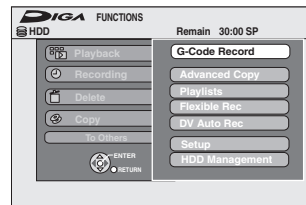

• If you press [RETURN], you can return to the previous screen.

### To exit the FUNCTIONS window

Press [FUNCTIONS].

Entering text/FUNCTIONS window/Child Lock

# Child Lock

e.g., **Australia and N.Z.**

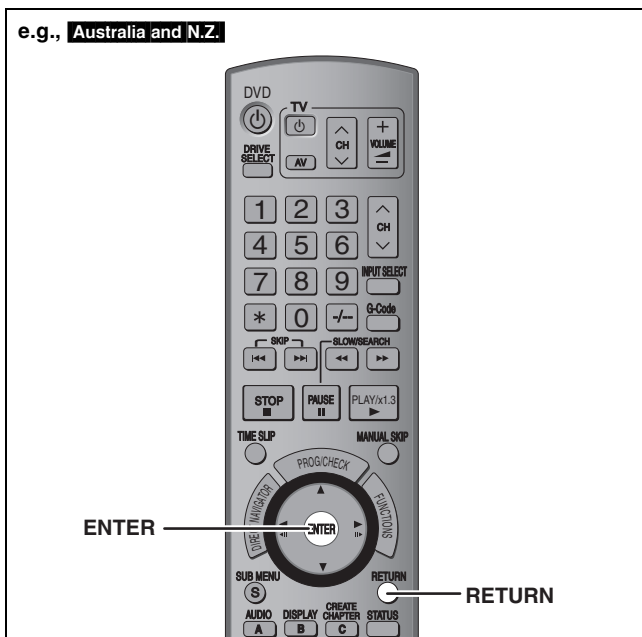

The Child Lock deactivates all buttons on the unit and remote control. Use it to prevent other people from operating the unit.

## Press and hold [ENTER] and [RETURN] simultaneously until “X HOLD” appears on the unit’s display.



If you press a button while the Child Lock is on, “X HOLD” appears on the unit’s display and operation is impossible.

### To cancel the Child Lock

Press and hold [ENTER] and [RETURN] simultaneously until “X HOLD” disappears.

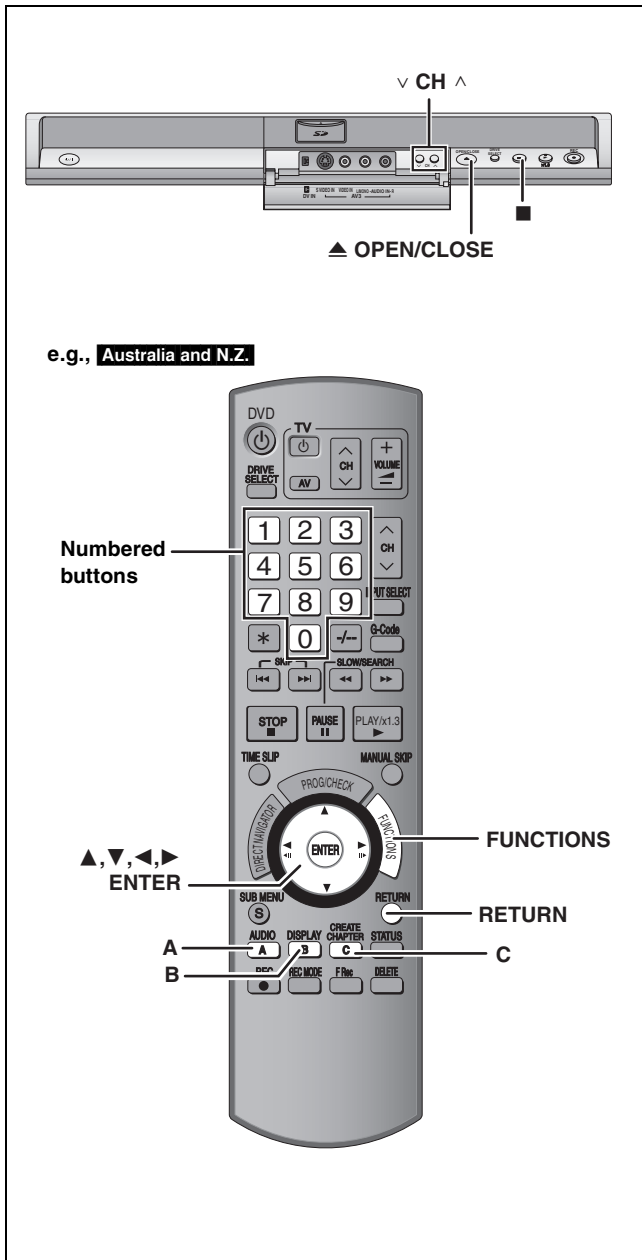

## Common procedures

- 1 While stopped  
Press [FUNCTIONS].
- 2 Press [▲, ▼] to select “To Others” and press [ENTER].
- 3 Press [▲, ▼] to select “Setup” and press [ENTER].
- 4 Press [▲, ▼] to select the tab and press [▶].

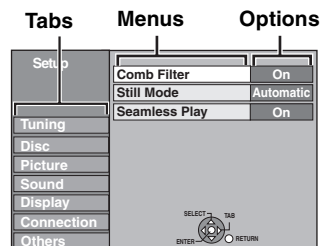

- 5 Press [▲, ▼] to select the menu and press [ENTER].
- 6 Press [▲, ▼] to select the option and press [ENTER].

**To return to the previous screen**

Press [RETURN].

**To exit the screen**

Press [RETURN] several times.

### Note

There may be differences in operation methods. If this happens, follow the on-screen instructions for the operation.

(continued on the next page)



(continued)

## Summary of settings

The settings remain intact even if you switch the unit to standby.

Tabs	Menus	Options (Underlined items are the factory presets.)
Tuning	Manual (⇒ 62)	
	Auto-Setup Restart (⇒ 63)	
Disc	<b>Settings for Playback</b> ● Press [ENTER] to show the following settings.	
	<b>Ratings</b> Set a ratings level to limit DVD-Video play.  Follow the on-screen instructions. Enter a 4-digit password with the numbered buttons when the password screen is shown. ● Do not forget your password.	<ul style="list-style-type: none"> <li>● <u>8 No Limit</u>: All DVD-Video can be played.</li> <li>● 1 to 7: Prohibits play of DVD-Video with corresponding ratings recorded on them.</li> <li>● 0 Lock All: Prohibits play of all DVD-Video.</li> </ul>
	<b>DVD-Audio Video mode Playback</b> Select "On" to play DVD-Video content on some DVD-Audio.	<ul style="list-style-type: none"> <li>● On: The setting returns to "Off" when you change the disc or turn the unit off.</li> <li>● <u>Off</u></li> </ul>
	<b>Soundtrack</b> Choose the language for audio, subtitle and disc menus. <b>DVD-V</b> ● Some discs start in a certain language despite any changes you make here. ● Enter a code (⇒ 64) with the numbered buttons when you select "Other ****".	<ul style="list-style-type: none"> <li>● <u>English</u>      ● German      ● French      ● Italian</li> <li>● Spanish</li> <li>● Original: The original language of each disc will be selected.</li> <li>● Other ****</li> </ul>
	<b>Subtitle</b> When the selected language is not available on the disc, the default language is played. There are discs where you can only switch the language from the menu screen (⇒ 29).	<ul style="list-style-type: none"> <li>● <u>Automatic</u>: If the language selected for "Soundtrack" is not available, subtitles of that language will automatically appear if available on that disc.</li> <li>● English      ● German      ● French      ● Italian</li> <li>● Spanish      ● Other ****</li> </ul>
	<b>Menus</b>	<ul style="list-style-type: none"> <li>● <u>English</u>      ● German      ● French      ● Italian</li> <li>● Spanish      ● Other ****</li> </ul>
	<b>Settings for Recording</b> ● Press [ENTER] to show the following settings.	
	<b>Recording time in EP mode</b> Select the maximum number of hours for recording in EP mode (⇒ 21, Recording modes and approximate recording times).	<ul style="list-style-type: none"> <li>● EP (6 Hours): You can record for 6 hours on an unused 4.7 GB disc.</li> <li>● <u>EP (8 Hours)</u>: You can record for 8 hours on an unused 4.7 GB disc. The sound quality is better when using "EP (6 Hours)" than when using "EP (8 Hours)".</li> </ul>
	<b>Rec for High Speed Copy</b> When high speed copying a title to DVD-R, DVD-R DL, DVD-RW (DVD-Video format), +R, +R DL and +RW, it is necessary to turn this setting "On" before recording to the HDD; however, the screen size, etc. is restricted (⇒ right). We recommend turning the setting "Off" if high speed copy to DVD-R, etc. is not necessary when recording a programme.	<ul style="list-style-type: none"> <li>● On: Makes high speed mode copying to DVD-R, etc. possible. Press [◀, ▶] to select "Yes" and press [ENTER]. – Pictures are saved in 4:3. – Select the type of audio in advance from "Bilingual Audio Selection" (⇒ 60).</li> <li>● <u>Off</u></li> </ul>
	<b>DVD Speed for High Speed Copy</b> Select the speed of high-speed copying (When using high-speed copy compatible DVD-RAM 5X, DVD-R, +R 8X or +RW 4X discs).	<ul style="list-style-type: none"> <li>● <u>Maximum</u></li> <li>● Normal (Silent): Selecting "Normal (Silent)" means the noise generated by this unit is less than "Maximum", however the time required for copying will double (approximately).</li> </ul>
Picture	<b>Comb Filter</b> Select the picture sharpness when recording. The setting is fixed with "On" if you set "TV System" to "NTSC" (⇒ 63).	<ul style="list-style-type: none"> <li>● On: Pictures become clear and vivid. Normally, use this setting.</li> <li>● Off: Select it when recording noisy pictures.</li> </ul>
	<b>Still Mode</b> Select the type of picture shown when you pause play (⇒ 73, Frames and fields).	<ul style="list-style-type: none"> <li>● <u>Automatic</u></li> <li>● Field: Select if jittering occurs when "Automatic" is selected. (The picture is coarser.)</li> <li>● Frame: Select if small text or fine patterns cannot be seen clearly when "Automatic" is selected. (The picture is clearer and finer.)</li> </ul>
	<b>Seamless Play</b> Select the play mode between playlist chapter segments and partially deleted titles.	<ul style="list-style-type: none"> <li>● On: The chapters in playlists are played seamlessly. This does not work when there are several audio types included on the playlist and when using Quick View. Additionally, the positioning of chapter segments may change slightly.</li> <li>● Off: The points where chapters in playlists change are played accurately, but the picture may freeze for a moment.</li> </ul>

Refer to the control reference on page 58.

Tabs	Menus	Options (Underlined items are the factory presets.)
<b>Sound</b>	<b>Dynamic Range Compression</b> <u>DVD-V</u> (Dolby Digital only) Change the dynamic range for late night viewing.	● On ● Off
	<b>Bilingual Audio Selection</b> Select whether to record the main or secondary audio type when: –Recording or copying to a DVD-R, DVD-R DL, DVD-RW (DVD-Video format), +R, +R DL and +RW. –“Rec for High Speed Copy” is set to “On” (⇒ 22). –Recording or copying sound in LPCM (⇒ below, “Audio Mode for XP Recording”).	● <u>M 1</u> ● M 2 You cannot select the audio on this unit when recording from an external source, such as when copying from a video cassette recorder (except from DV equipment connected to this unit's DV input terminal). Select on the other equipment. When recording from the unit's DV terminal, select the type of audio recording from “Audio Mode for DV Input” (⇒ below).
	<b>Digital Audio Output</b> Change the settings when you have connected equipment through this unit's DIGITAL AUDIO OUT terminal (⇒ 15). ● Press [ENTER] to show the following settings.	<b>PCM Down Conversion</b> Select how to output audio with a sampling frequency of 96 kHz or 88.2 kHz. ● Signals are converted to 48 kHz or 44.1 kHz despite the settings across if the signals have a sampling frequency of over 96 kHz or 88.2 kHz, or the disc has copy protection. ● On: Signals are converted to 48 kHz or 44.1 kHz. (Choose when the connected equipment cannot process signals with a sampling frequency of 96 kHz or 88.2 kHz.) ● Off: Signals are output as 96 kHz or 88.2 kHz. (Choose when the connected equipment can process signals with a sampling frequency of 96 kHz or 88.2 kHz.)
	<b>Dolby Digital</b>  Select how to output the signal. Select “Bitstream” if the connected equipment decodes the signal. Select “PCM” if this unit decodes the signal and outputs it as 2 channels.	● <u>Bitstream</u> : When connecting to equipment displaying the Dolby Digital logo. ● PCM: When connecting to equipment not displaying the Dolby Digital logo.
	<b>DTS</b>  <b>Note</b> Not making the proper settings may result in noise or some trouble for digital recording.	● <u>Bitstream</u> : When connecting to equipment displaying the DTS logo. ● PCM: When connecting to equipment not displaying the DTS logo.
	<b>MPEG</b>	● <u>Bitstream</u> : When connected to equipment with a built-in MPEG decoder. ● PCM: When connected to equipment without a built-in MPEG decoder.
<b>Audio Mode for XP Recording</b> Choose the audio type when recording or copying with XP mode.	● <u>Dolby Digital</u> (⇒ 73) ● <u>LPCM</u> (⇒ 73) –The picture quality of LPCM recordings may be lower than that of normal XP mode recordings. –The audio recording becomes Dolby Digital even if you selected LPCM when using a recording mode other than XP. –When recording a bilingual broadcast, select the type of audio in advance from “Bilingual Audio Selection” (⇒ above).	
<b>Audio Mode for DV Input</b> You can select the kind of audio when recording from the unit's DV input terminal (⇒ 52).	● <u>Stereo 1</u> : Records audio (L1, R1). ● <u>Stereo 2</u> : Records added audio such as narration (L2, R2) subsequent to original recording. ● <u>Mix</u> : Records both Stereo 1 and Stereo 2. When recording bilingual broadcast, select the type of audio in advance from “Bilingual Audio Selection” (⇒ above).	
<b>Display</b>	<b>On-Screen Messages</b> Choose whether to show status messages automatically.	● <u>Automatic</u> ● Off
	<b>Grey Background</b> Select “Off” if you do not want to have the unit show the grey background when tuner reception is weak.	● <u>On</u> ● Off
	<b>FL Display</b> Changes the brightness of the unit's display. This setting is fixed with “Automatic” if you set “Power Save” (⇒ 61) to “On”.	● <u>Bright</u> ● Dim ● Automatic: The display turns dark during play and disappears when the unit is turned off. It reappears momentarily if a button is pressed. While using this mode, the standby power consumption can be reduced.

Tabs	Menus	Options (Underlined items are the factory presets.)
Connection	<b>TV Aspect (⇒ 17)</b> Set to match the type of television connected.	●16:9      ● <u>4:3</u> ●Letterbox ●On      ● <u>Off</u>
	<b>Progressive (⇒ 18)</b> This setting is fixed with "Off" if you set "AV1 Output" to "RGB 1 (without component)" or "RGB 2 (without component)".	
	<b>TV System (⇒ 63)</b>	● <u>PAL</u> ●NTSC
	<b>HDMI Settings</b> ●Press [ENTER] to show the following settings.	
	<b>HDMI Video Format</b> You can only select items compatible with the connected equipment. This setting normally does not need to be changed. However if you are concerned about output picture quality, it may be improved by changing the setting. Still pictures play at a resolution equivalent to 480p regardless of the settings.	●576i/480i ●576p/480p ●720p ●1080i ● <u>Automatic</u> : Automatically selects the output resolution best suited to the connected television (1080i, 720p, 576p/480p or 576i/480i).
	<b>Aspect for 4:3 Video</b>	●4:3: Picture is output as original aspect. ●16:9: Picture is output as 16:9 aspect with side panels.
	<b>Digital Audio Output</b>	● <u>HDMI and Optical</u> ●Optical Only: Select when this unit is connected to an amplifier with an optical digital audio cable and connected to a TV with an HDMI cable and you want to enjoy the highest quality of audio from discs (⇒ 15).
	<b>Control with HDMI</b>	● <u>On</u> ●Off: Select when you do not want to use Control with HDMI.
	<b>AV1 Output</b> Selects the output from the AV1 terminal. Select "RGB 1 (without component)" or "RGB 2 (without component)" for RGB output. Select "Video (with component)" or "S Video (with component)" for component output (progressive output). Set according to the signal and terminal of the connected TV.  ●If this unit is connected with an HDMI cable, you cannot select "RGB 1 (without component)" or "RGB 2 (without component)".	● <u>Video (with component)</u> : Select when a TV is connected that can receive a composite signal. ●S Video (with component): Select when a TV is connected that can receive an S Video signal. ●RGB 1 (without component): Select when a TV is connected that can receive an RGB signal. If you always would like to view the picture from the unit in RGB signal, select this mode. The TV screen will automatically switch to display the picture from the unit when the unit is turned on. ●RGB 2 (without component): Select when a TV is connected that can receive an RGB signal. If you would like to switch to display the picture from the unit only when playback or viewing menus, select this mode.
	<b>AV2 Input</b> This setting is according to the output signal of the connected equipment.	● <u>Video</u> ●S Video
Others	<b>Remote Control (⇒ 19)</b>	● <u>DVD 1</u> ●DVD 2      ●DVD 3
	<b>Clock (⇒ 64)</b>	
	<b>Power Save</b> ●Refer to the following when "Power Save" is set to "On". –"FL Display" is automatically set to "Automatic" (⇒ 60). –The "Quick Start" function does not work. (It is automatically turned to "Off".) ●If "Quick Start" is set to "On", "Power Save" is automatically turned to "Off".	●On: Power consumption is minimized when the unit is turned to standby (⇒ 74). ● <u>Off</u>
	<b>Quick Start</b> The Quick Start feature enables this unit to be ready to start recording as quick as approx. 1 second* after turning it on. You can start recording soon after deciding you want to record something. *Only when recording to the HDD or DVD-RAM. ●If this is set to "On", "Power Save" is automatically turned to "Off". ●Startup takes up to a minute when: –You play a disc or start recording to discs other than DVD-RAM. –You want to make other operations. –The clock has not been set.	● <u>On</u> ●Off: Standby power consumption is less than when this is set to "On".
	<b>For Australia and N.Z. Country</b>	● <u>Australia</u> ●New Zealand ●Others
	<b>DivX Registration</b>	●You need this registration code to purchase and play DivX Video-on-Demand (VOD) content (⇒ 33).
	<b>Initialize</b> ●Press [ENTER] to show the following settings.	
	<b>Shipping Condition</b> All the settings except for the ratings level, ratings password and time settings return to the factory preset. The timer recording programmes are also cancelled.	●Yes ● <u>No</u>
	<b>Default Settings</b> All the settings other than the programmed channels, time settings, country settings*, disc language settings, ratings level, ratings password, remote control code, return to the factory presets. * Only for Australia and N.Z.	●Yes ● <u>No</u>

Refer to the control reference on page 58.

## Tuning

- 1 While stopped  
Press [FUNCTIONS].
- 2 Press [▲, ▼] to select "To Others" and press [ENTER].
- 3 Press [▲, ▼] to select "Setup" and press [ENTER].
- 4 Press [▲, ▼] to select "Tuning" and press [▶].

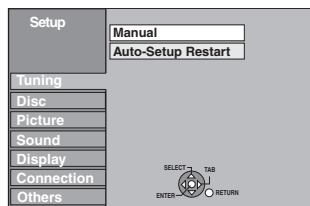

### Manual

You can add or delete channels, or change programme positions.

- 5 Press [▲, ▼] to select "Manual" and press [ENTER].

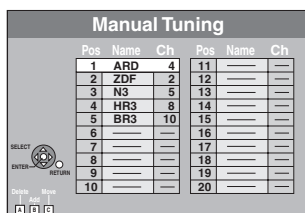

#### To delete a programme position

Press [▲, ▼, ◀, ▶] to select a programme position and press [A].

#### To add a blank programme position

Press [▲, ▼, ◀, ▶] to select a programme position and press [B].

#### To move a TV station to another programme position

- ① Press [▲, ▼, ◀, ▶] to select a programme position and press [C].
- ② Press [▲, ▼, ◀, ▶] to select the new programme position to which you want to assign the TV station and press [ENTER].

#### ■ To change the tuning settings for individual programme position

- 6 Press [▲, ▼, ◀, ▶] to select a programme position and press [ENTER].

e.g., **Australia and N.Z.**

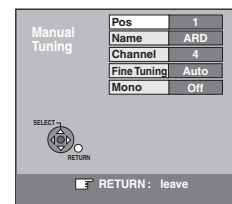

Press [▲, ▼] to select an item and press [▶].

<b>Pos</b>	<b>To change the programme position in which the TV stations are assigned</b> Press [▲, ▼] or numbered buttons to select the number of the desired programme position and press [ENTER].
<b>Name</b>	<b>To enter or change the name of a TV station</b> Press [▲, ▼, ◀, ▶] to enter station name and press [ENTER]. If the station name needs a blank space, select the blank between "Z" and "*".
<b>Channel</b>	<b>To enter newly available TV stations or change the channel number of an already tuned TV station</b> Press [▲, ▼] or the numbered buttons to enter the channel number of the desired TV station. Wait a few moments until the desired TV station has been tuned. After the desired TV station is tuned, press [ENTER].
<b>Fine Tuning</b>	<b>To obtain the best tuning condition</b> Press [▲, ▼] to adjust the best tuning condition and press [ENTER]. ● Press [▶] to return to "Auto".
<b>Video System*</b>	<b>To select the video system type</b> Press [▲, ▼] to select "PAL" or "SECAM" if the picture lacks colour, and press [ENTER]. Auto: This unit automatically distinguishes PAL and SECAM signals. PAL: For receiving PAL signals. SECAM: For receiving SECAM signals.  This setting is also available when you select the external input channel (AV1, AV2, AV3, AV4) in step 5. In order to record properly, make the appropriate settings to match the connected equipment.
<b>Audio Mode*</b>	<b>To select the audio reception type</b> If sound quality is poor, press [▲, ▼] to select "BG", "I" or "DK" and press [ENTER]. BG: PAL B.G. I: PAL I DK: PAL D.K.K1
<b>Mono</b>	<b>To select the type of sound to be recorded</b> Press [▲, ▼] to select "On" if the stereo sound is distorted due to inferior reception conditions, or if you want to record the normal (mono) sound during a stereo, bilingual or NICAM broadcast, and press [ENTER].

\* Only for Asia and Middle East



### Restart set up

You can restart auto channel setting if set up (⇒ 17) fails for some reason.  
**After performing steps 1–4 (⇒ 62)**

**5** Press [▲, ▼] to select “Auto-Setup Restart” and press [ENTER].

The confirmation screen appears.

**6** Press [◀, ▶] to select “Yes” and press [ENTER].

**For Australia and N.Z.**

- If the country setting menu appears on the television Press [▲, ▼] to select the country and press [ENTER].

You can also use the following method to restart Auto-Setup. When the unit is on and stopped Press and hold [v CH] and [CH ^] on the main unit until the Country setting screen\* or the Auto-Setup screen appears. All the settings except for the ratings level, ratings password and time settings return to the factory preset. The timer recording programmes are also cancelled.

\* Only for Australia and N.Z.

**To return to the previous screen**

Press [RETURN].

**To exit the screen**

Press [RETURN] several times.

### List of TV Reception Channels

**For Asia**

Tuner System	Channel Coverage	VHF	UHF	CATV
PAL-BGH, SECAM-BG	CCIR	E2-E12	E21-E69	S01-S05 M1-M10 U1-U10 S21-S41
PAL-I	Hong Kong	—	21-69	—
PAL-DK, SECAM-DKK1	OIRT	R1-R12	21-69	44 MHz to 470 MHz
PAL-D	China	1-12	13-57	Z1-Z35

**For Australia and N.Z.**

Tuner System	Channel Coverage	VHF	UHF	CATV
PAL-B	Australia	0-12	28-69	45 MHz to 470 MHz
PAL-BG	New Zealand	1-11	21-69	44 MHz to 470 MHz

**For Middle East**

Tuner System	Channel Coverage	VHF	UHF	CATV
PAL-BGH, SECAM-BG	CCIR	E2-E12	E21-E69	S01-S05 M1-M10 U1-U10 S21-S41

## TV System

Change the setting to match the equipment you are connecting with, or to match the title when there are both PAL and NTSC titles on the HDD.

- 1** While stopped Press [FUNCTIONS].
- 2** Press [▲, ▼] to select “To Others” and press [ENTER].
- 3** Press [▲, ▼] to select “Setup” and press [ENTER].
- 4** Press [▲, ▼] to select “Connection” and press [▶].
- 5** Press [▲, ▼] to select “TV System” and press [ENTER].
- 6** Press [▲, ▼] to select the TV system and press [ENTER].

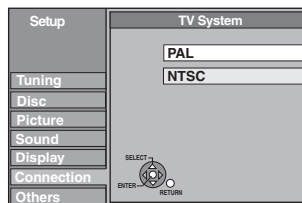

**•PAL (factory preset)**

- Select when connecting to a PAL or Multi-system television. Titles recorded using NTSC are played as PAL 60.
- Select to record television programmes and PAL input from other equipment.
- HDD** Select when playing a PAL input title recorded on the HDD.

**•NTSC**

- Select when connecting to a NTSC television. Television programmes cannot be recorded properly.
- Select to record NTSC input from other equipment.
- HDD** Select when playing a NTSC input title recorded on the HDD.

**7** Press [◀, ▶] to select “Yes” and press [ENTER].

**To return to the previous screen**

Press [RETURN].

**To exit the screen**

Press [RETURN] several times.

**■ To change the setting all at once (PAL↔NTSC)**

While stopped, keep pressing [■] and [▲ OPEN/CLOSE] on the main unit for 5 or more seconds.

**Note**

- This unit cannot record to discs containing both PAL and NTSC signals. (However, both types of programmes can be recorded onto the HDD.)

Refer to the control reference on page 58.

## Clock Settings

In the case of a power failure, the clock setting remains in memory for approximately 60 minutes.

- 1** While stopped  
Press [FUNCTIONS].
- 2** Press [▲, ▼] to select “To Others” and press [ENTER].
- 3** Press [▲, ▼] to select “Setup” and press [ENTER].
- 4** Press [▲, ▼] to select “Others” and press [▶].
- 5** Press [▲, ▼] to select “Clock” and press [ENTER].

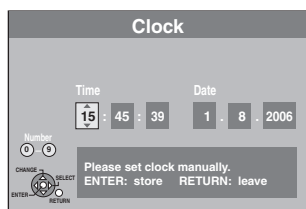

- 6** Press [◀, ▶] to select the item you want to change.

The items change as follows:

Hour ↔ Minute ↔ Second ↔ Day ↔ Month ↔ Year

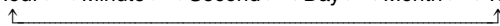

- 7** Press [▲, ▼] to change the setting.

You can also use the numbered buttons for setting.

- 8** Press [ENTER] when you have finished the settings.

The clock starts.

**To return to the previous screen**

Press [RETURN].

**To exit the screen**

Press [RETURN] several times.

### Language code list Enter the code with the numbered buttons.

Abkhazian: 6566	Catalan: 6765	Gujarati: 7185	Lingala: 7678	Rhaeto-Romance: 8277	Tamil: 8465
Afar: 6565	Chinese: 9072	Hausa: 7265	Lithuanian: 7684	Tatar: 8484	
Afrikaans: 6570	Corsican: 6779	Hebrew: 7387	Macedonian: 7775	Romanian: 8279	Telugu: 8469
Albanian: 8381	Croatian: 7282	Hindi: 7273	Malagasy: 7771	Russian: 8285	Thai: 8472
Ameharic: 6577	Czech: 6783	Hungarian: 7285	Malay: 7783	Samoan: 8377	Tibetan: 6679
Arabic: 6582	Danish: 6865	Icelandic: 7383	Malayalam: 7776	Sanskrit: 8365	Tigrinya: 8473
Armenian: 7289	Dutch: 7876	Indonesian: 7378	Maltese: 7784	Scots Gaelic: 7168	Tonga: 8479
Assamese: 6583	English: 6978	Interlingua: 7365	Maori: 7773	Serbian: 8382	Turkish: 8482
Aymara: 6589	Esperanto: 6979	Irish: 7165	Marathi: 7782	Serbo-Croatian: 8372	Turkmen: 8475
Azerbaijani: 6590	Estonian: 6984	Italian: 7384	Moldavian: 7779	Shona: 8378	Twi: 8487
Bashkir: 6665	Faroese: 7079	Japanese: 7465	Mongolian: 7778	Sindhi: 8368	Ukrainian: 8575
Basque: 6985	Fiji: 7074	Javanese: 7487	Nauru: 7865	Singhalese: 8373	Urdu: 8582
Bengali; Bangla: 6678	Finnish: 7073	Kannada: 7578	Nepali: 7869	Slovak: 8375	Uzbek: 8590
	French: 7082	Kashmiri: 7583	Norwegian: 7879	Slovenian: 8376	Vietnamese: 8673
Bhutani: 6890	Frisian: 7089	Kazakh: 7575	Oriya: 7982	Somali: 8379	Volapük: 8679
Bihari: 6672	Galician: 7176	Kirghiz: 7589	Pashto, Pushto: 8083	Spanish: 6983	Welsh: 6789
Breton: 6682	Georgian: 7565	Korean: 7579	Persian: 7065	Sundanese: 8385	Wolof: 8779
Bulgarian: 6671	German: 6869	Kurdish: 7585	Polish: 8076	Swahili: 8387	Xhosa: 8872
Burmese: 7789	Greek: 6976	Laotian: 7679	Portuguese: 8084	Swedish: 8386	Yiddish: 7473
Byelorussian: 6669	Greenlandic: 7576	Latin: 7665	Punjabi: 8065	Tagalog: 8476	Yoruba: 8979
Cambodian: 7577	Guarani: 7178	Latvian, Lettish: 7686	Quechua: 8185	Tajik: 8471	Zulu: 9085

## On the television

Page

Authorization Error.	<ul style="list-style-type: none"> <li>You are trying to play the DivX VOD content that was purchased with a different registration code. You cannot play the content on this unit. (DivX)</li> </ul>	32, 33
Cannot finish recording completely.	<ul style="list-style-type: none"> <li>The programme was copy-protected.</li> <li>The HDD or disc may be full.</li> <li>The maximum number of times you can record the program is exceeded.</li> </ul>	— — 20
Cannot playback. TV system is different from the setting. To playback, please change the TV System in Setup.	<ul style="list-style-type: none"> <li>You tried to play a title recorded using a different encoding system from that of the TV system currently selected on the unit. Alter the "TV System" setting on this unit to suit.</li> </ul>	63
Cannot record on the disc.	<ul style="list-style-type: none"> <li>The disc may be dirty or scratched.</li> </ul>	10
Unable to format.		
Cannot play on this unit.	<ul style="list-style-type: none"> <li>You tried to play a non-compatible image.</li> <li>Turn the unit off and re-insert the card.</li> </ul>	31 13
Cannot output Audio with HDMI because of copyright protection.	<ul style="list-style-type: none"> <li>Should you connect equipment that does not support CPPM the audio from the CPPM copy protected DVD-Audio cannot be output from HDMI AV OUT terminal. Connect the audio cables (red, white) or optical digital cable to the corresponding terminals.</li> </ul>	14, 15
Cannot record. Disc is full.	<ul style="list-style-type: none"> <li><b>HDD RAM -RW(V) +RW</b> Create space by deleting any unnecessary titles. [Even if you delete recorded content from the DVD-R, DVD-R DL, +R or +R DL there is no increase in disc space. Available space on DVD-RW (DVD-Video format) and +RW increases only when the last recorded title is deleted.]</li> <li>Use a new disc.</li> </ul>	39, 44, 54
Cannot record. Maximum number of titles exceeded.	<ul style="list-style-type: none"> <li></li> </ul>	—
No Disc	<ul style="list-style-type: none"> <li>The disc may be upside down.</li> </ul>	—
No folders.	<ul style="list-style-type: none"> <li>There is no compatible folder in this unit.</li> </ul>	7, 31
No SD CARD No valid SD card.	<ul style="list-style-type: none"> <li>The card is not inserted. If this message is displayed with a compatible card already inserted, turn off the unit, remove and then re-insert the card.</li> <li>The card inserted is not compatible or the card format does not match.</li> </ul>	13 7
Not enough space in the copy destination.	<ul style="list-style-type: none"> <li>Create space by deleting any unnecessary items.</li> <li>Delete one or more items registered on the copy list to ensure that the "Destination Capacity" is not exceeded.</li> </ul>	39, 43, 44, 54  48, 51
This is a non-recordable disc.	<ul style="list-style-type: none"> <li>The unit cannot record on the disc you inserted. Insert a DVD-RAM or unfinalized DVD-R, DVD-RW (DVD-Video format), +R or +RW.</li> <li>You inserted an unformatted DVD-RAM, DVD-RW, +R, +R DL or +RW.</li> <li>You cannot directly record to a DVD-R DL and +R DL disc on this unit. Record to the HDD and then copy to the disc.</li> </ul>	4-5 54 —
Not enough space on HDD. Space of 4 hours (in SP mode) is necessary.  Maximum number of titles is recorded on HDD. Please delete unnecessary titles.	<ul style="list-style-type: none"> <li><b>-R DL +R DL</b> It is not possible to copy when there is not enough free space on the HDD or when the total number of the recorded titles on the HDD and the titles to be copied are greater than 500. Delete unwanted titles from the HDD.</li> </ul>	44
Rental Expired.	<ul style="list-style-type: none"> <li>The DivX VOD content has zero remaining plays. You cannot play it. (DivX)</li> </ul>	33
⊘	<ul style="list-style-type: none"> <li>The operation is prohibited by the unit or disc.</li> </ul>	—

**On the unit's display**

The following messages or service numbers appear on the unit's display when something unusual is detected during startup and use.

		Page
<b>DVD □</b> ("□" stands for a number.)	<ul style="list-style-type: none"> <li>The remote control and main unit are using different codes. Change the code on the remote control.</li> </ul>  <p>Press and hold [ENTER] and the indicated number button at the same time for more than 2 seconds.</p>	19
<b>HARD ERR*</b>	<ul style="list-style-type: none"> <li>If there is no change after turning the unit on and off, consult the dealer where the unit was purchased.</li> </ul>	—
<b>No AUDIO*</b>	<ul style="list-style-type: none"> <li>When connecting to CPPM incompatible equipment with an HDMI cable, CPPM copy protected DVD-Audio cannot output audio through the HDMI AV OUT terminal. Connect the audio cables (red, white) or optical digital cable to the corresponding terminals.</li> </ul>	14, 15
<b>NoERAS</b>	<ul style="list-style-type: none"> <li>You cannot delete items on this disc. The disc may be damaged. Use a new disc.</li> </ul>	—
<b>NoREAD</b>	<ul style="list-style-type: none"> <li>The disc is dirty or badly scratched. The unit cannot record, play, or edit.</li> <li>This message may appear when the DVD lens cleaner has finished cleaning. Press [<b>▲</b> OPEN/CLOSE] on the main unit to eject the disc.</li> </ul>	10 10
<b>NoWRIT</b>	<ul style="list-style-type: none"> <li>You cannot write to this disc. The disc may be damaged. Use a new disc.</li> </ul>	—
<b>PLEASE WAIT*</b>	<ul style="list-style-type: none"> <li>There was a power failure or the AC plug was disconnected while the unit was on. The unit is carrying out its recovery process. This process restores the unit to normal operation. The unit is not broken. Wait until the message disappears.</li> </ul>	—
<b>PROG FULL*</b>	<ul style="list-style-type: none"> <li>There are already 32 timer programmes. Delete unnecessary timer programmes.</li> </ul>	27
<b>SLEEP</b>	<ul style="list-style-type: none"> <li>In order to extend HDD life, the HDD is in SLEEP mode.</li> </ul>	9
<b>SP 35:50</b> <b>LP 151h</b> "SP","LP" and the numbers are examples.	<ul style="list-style-type: none"> <li>Available space on the HDD or disc. The example "SP 35:50" is displayed when less than 100 hours are available and the example "LP 151h" is displayed when over 100 hours are available. "SP" and "LP" are recording modes, "35:50" means "35 hours 50 minutes" and "151h" means "151 hours".</li> </ul>	—
<b>UNFORMAT*</b>	<ul style="list-style-type: none"> <li>You inserted an unformatted DVD-RAM, DVD-RW, +RW, an unused +R, +R DL or DVD-RW (DVD-Video format) that has been recorded on other equipment. Format the disc to use it. However all the recorded contents on the disc are deleted.</li> </ul>	54
<b>UNSUPPORT*</b>	<ul style="list-style-type: none"> <li>You have inserted a disc the unit cannot play or record on.</li> </ul>	4-6
<b>F74</b>	<ul style="list-style-type: none"> <li>The HDMI connection could not be authenticated due to a transfer malfunction. Consult the dealer where the unit was purchased.</li> </ul>	—
<b>F75</b>	<ul style="list-style-type: none"> <li>The HDMI connection could not be authenticated due to an internal data malfunction. Consult the dealer where the unit was purchased.</li> </ul>	—
<b>U59</b>	<ul style="list-style-type: none"> <li>The unit is hot. The unit switches to standby for safety reasons. Wait for about 30 minutes until the message disappears. Select a position with good ventilation when installing the unit. Do not block the cooling fan on the rear of the unit.</li> </ul>	—
<b>U61</b>	<ul style="list-style-type: none"> <li>(When a disc is not inserted) Displays when a malfunction has occurred during recording, playback or copy. This is displayed when the unit is in the recovery process to return to normal operation; it is not broken. Once the display clears you can use the unit again.</li> </ul>	—
<b>U71</b>	<ul style="list-style-type: none"> <li>The connected equipment is not HDMI compatible.</li> </ul>	—
<b>U72</b> <b>U73</b>	<ul style="list-style-type: none"> <li>The HDMI connection acts unusually.                             <ul style="list-style-type: none"> <li>The connected equipment is not HDMI compatible.</li> <li>Please use HDMI cables that have the HDMI logo (as shown on the cover).</li> <li>The HDMI cable is damaged.</li> </ul> </li> </ul>	—
<b>U88</b>	<ul style="list-style-type: none"> <li>(When a disc is inserted) Displays when there was something unusual detected with the disc while recording, playback or copy. This is displayed when the unit is in the recovery process to return to normal operation; it is not broken. Once the display clears you can use the unit again.</li> </ul>	68
<b>U99</b>	<ul style="list-style-type: none"> <li>The unit fails to operate properly. Press [<b>⏻/ </b>] on the main unit to switch the unit to standby. Now press [<b>⏻/ </b>] on the main unit again to turn the unit on.</li> </ul>	—
<b>H□□ or F□□</b>	<ul style="list-style-type: none"> <li>There is something unusual. (The service number displayed after H and F depends on the unit's condition.)</li> <li>Check the unit using the troubleshooting guide. If the service number does not disappear, do the following.                             <ol style="list-style-type: none"> <li>Disconnect the plug from the household mains socket, wait a few seconds, then reconnect it.</li> <li>Press [<b>⏻/ </b>] to turn the power on. (The unit may be fixed.)</li> </ol>                             If the service number does not disappear despite after doing the above, request service from the dealer. Inform the dealer of the service number when requesting service.                         </li> </ul>	— 68-72
<b>X HOLD</b>	<ul style="list-style-type: none"> <li>The Child Lock function is activated. Press and hold [ENTER] and [RETURN] simultaneously until "X HOLD" disappears.</li> </ul>	57

\*The message are alternately displayed.

# Frequently asked questions

Refer to the following items if you have any doubts about unit operations.

<b>Set up</b>		<b>Page</b>
What equipment is necessary to play multi channel surround sound?	<ul style="list-style-type: none"> <li>You cannot playback multi-channel sound on this unit without other equipment. You must connect this unit with an HDMI cable or an optical digital cable to an amplifier with a built-in (Dolby Digital, DTS or MPEG) decoder.</li> <li>An amplifier supporting CPPM and the HDMI standard (version 1.1 or later) must be connected to this unit to play multi-channel audio on a DVD-Audio.</li> </ul>	15, 16
Are the headphones and speakers directly connected to the unit?	<ul style="list-style-type: none"> <li>You cannot directly connect them to the unit. Connect through the amplifier etc.</li> </ul>	16
The television has both S VIDEO IN terminal and COMPONENT VIDEO IN terminals. Which terminal should I connect with?	<ul style="list-style-type: none"> <li>Connecting with the component video out terminal provides a more vivid picture compared to connecting with the S Video out terminal. If you have an LCD/plasma television or LCD projector compatible with progressive scan, connect through the component video terminals for high-quality progressive video. If you have a CRT television or a multi system television using PAL mode that is compatible with progressive scan, we cannot recommend progressive output as some flickering can occur.</li> </ul>	15
Is my television progressive output compatible?	<ul style="list-style-type: none"> <li>All Panasonic televisions that have 625 (576)/50i · 50p, 525 (480)/60i · 60p input terminals are compatible. Consult the manufacturer if you have another brand of television.</li> </ul>	—
<b>Disc</b>		
Can I play DVD-Video, DVD-Audio and Video CDs bought in another country?	<ul style="list-style-type: none"> <li>You cannot play DVD-Video if their region numbers are not supported by this unit. Refer to the disc's jacket for more information.</li> </ul>	Cover
Can a DVD-Video that does not have a region number be played?	<ul style="list-style-type: none"> <li>The DVD-Video region number indicates the disc conforms to a standard. You cannot play discs that do not have a region number. You also cannot play discs that do not conform to a standard.</li> </ul>	—
Please tell me about disc compatibility with this unit.	<ul style="list-style-type: none"> <li>This unit records and plays DVD-R, DVD-RW (DVD-Video format), +R, and +RW, and plays DVD-RW (DVD Video Recording format). However you cannot directly record to a DVD-R DL or +R DL disc on this unit (playback and copy are possible).</li> <li>This unit also records and plays high speed recording compatible DVD-R, DVD-R DL, DVD-RW, +R, +R DL, +RW discs.</li> </ul>	4–6
Please tell me about CD-R and CD-RW compatibility with this unit.	<ul style="list-style-type: none"> <li>This unit plays CD-R/CD-RW discs which have been recorded in one of the following standards: CD-DA, Video CD, DivX, MP3 and still pictures (JPEG/TIFF).</li> <li>You cannot write to a CD-R or CD-RW with this unit.</li> </ul>	6, 31
<b>Recording</b>		
Can I record from a commercially purchased video cassette or DVD?	<ul style="list-style-type: none"> <li>Most commercially sold video cassettes and DVD are copy protected; therefore, recording is usually not possible.</li> </ul>	—
Can DVD-R, DVD-R DL, DVD-RW (DVD-Video format), +R, +R DL and +RW recorded on this unit be played on other equipment?	<ul style="list-style-type: none"> <li>You can play on compatible equipment such as DVD players after finalizing the disc on this unit. However, depending on the condition of the recording, the quality of the disc and capabilities of the DVD player, play may not be possible.</li> <li>If you play a DVD-R DL, +R DL or +RW, use compatible equipment.</li> </ul>	—
Can I record digital audio signals using this unit?	<ul style="list-style-type: none"> <li>You cannot record digital signals. The digital audio terminals on this unit are for output only. (The audio recorded using the unit's DV input terminal from a digital video camcorder, for example, is recorded digitally.)</li> </ul>	—
Can a digital audio signal from this unit be recorded to other equipment?	<ul style="list-style-type: none"> <li>You can record if using the PCM signal. When recording DVD, change the "Digital Audio Output" settings to the following in the Setup menu.                             <ul style="list-style-type: none"> <li>–PCM Down Conversion: On</li> <li>–Dolby Digital/DTS/MPEG: PCM</li> </ul>                             However, only as long as digital recording from the disc is permitted and the recording equipment is compatible with a sampling frequency of 48 kHz.                         </li> <li>You cannot record MP3 signals.</li> </ul>	60
Can I switch to bilingual broadcast during recording?	<ul style="list-style-type: none"> <li>With HDD and DVD-RAM, you can. Just press [AUDIO].</li> <li>With DVD-R, DVD-RW (DVD-Video format), +R, +RW you cannot. Change before recording with "Bilingual Audio Selection" in the Setup menu.</li> </ul>	30 60
Can I high speed copy to a disc?	<ul style="list-style-type: none"> <li>Yes, you can. Depending on the disc type, the maximum speed varies.</li> </ul>	45

# Troubleshooting guide

Before requesting service, make the following checks. If you are in doubt about some of the check points, or if the solutions indicated in the chart do not solve the problem, consult your dealer for instructions.

## The following do not indicate a problem with this unit:

<ul style="list-style-type: none"> <li>● Regular disc rotating sounds.</li> <li>● Poor reception due to atmospheric conditions.</li> <li>● Image disturbance during search.</li> <li>● Interruptions in reception due to periodic satellite broadcasting breaks.</li> <li>● A sound is heard when the HDD goes into SLEEP mode, or operations are slow to respond in SLEEP mode.</li> </ul>	<ul style="list-style-type: none"> <li>● Operations do not work due to a poor-quality disc. (Try again using a Panasonic disc.)</li> <li>● <b>The unit freezes due to one of its safety devices being activated. (Press and hold [⏻/I] on the main unit for 10 seconds.)</b></li> <li>● When the HDD has been automatically placed in the SLEEP mode (→ 9), or the unit is turned on or off, there may be an unexpected sound. This does not indicate a problem with this unit.</li> </ul>
---	--

Power		Page
<b>No power.</b> <b>The unit does not turn on pressing [⏻ DVD].</b>	● Insert the AC mains lead securely into a known active household mains socket.	14
<b>The unit switches to standby mode.</b>	● One of the unit's safety devices is activated. Press [⏻/I] on the main unit to turn the unit on.	—

Displays		Page
<b>The display is dim.</b>	● Change "FL Display" in the Setup menu.	60
<b>"0:00" is flashing on the unit's display.</b>	● Set the clock.	64
<b>The time recorded on the disc and the available time shown do not add up.</b>	● Times shown may disagree with actual times.	—
<b>The play time shown for MP3 does not agree with the actual time.</b>	● Available recording space on DVD-RW (DVD-Video format) or +RW increases only when the last recorded title is deleted. It does not increase if other titles are deleted.	—
	● Even if you delete recorded content from the DVD-R, DVD-R DL, +R or +R DL, there is no increase in disc space.	—
	● More disc space than the actual recording time is used after recording or editing the DVD-R, DVD-R DL, +R or +R DL 200 times or more.	—
	● While searching, the elapsed time may not display correctly.	—
<b>Compared to the actual recorded time, the elapsed time displayed is less.</b> <b>(Only when recording in NTSC)</b>	● The displayed recording/play time is converted from the number of frames at 29.97 frames (equal to 0.999 seconds) to one second. There will be a slight difference between the time displayed and the actual elapsed time (e.g., actual one-hour elapsed time may display as approximately 59 minutes 56 seconds). This does not affect the recording.	—
<b>"U88" is displayed and the disc cannot be ejected.</b>	<ul style="list-style-type: none"> <li>● The unit is carrying out the recovery process. Do the following to eject the disc. <ol style="list-style-type: none"> <li>1 Press [⏻/I] on the main unit to switch the unit to standby. If the unit doesn't switch to standby, press and hold [⏻/I] on the main unit for about 10 seconds. The unit is forcibly switched to standby.</li> <li>2 While the unit is off, press and hold [■] and [CH ^] on the main unit at the same time for about 5 seconds. Remove the disc.</li> </ol> </li> </ul>	—

TV screen and video		Page
<b>Television reception worsens after connecting the unit.</b>	● This can occur because the signals are being divided between the unit and other equipment. It can be solved by using a signal booster, available from audio-visual suppliers. If it is not solved by using a signal booster, consult the dealer.	—
<b>Status messages do not appear.</b>	● Select "Automatic" in "On-Screen Messages" in the Setup menu.	60
<b>The grey background does not appear.</b>	● Select "On" in "Grey Background" in the Setup menu.	60
<b>Picture does not appear during timer recording.</b>	● Timer recordings work regardless whether the unit is on or off. To confirm the timer recording is going to work properly, turn the unit on.	—
<b>The 4:3 aspect ratio picture expands left and right.</b>	● Use the television to change the aspect. If your television does not have that function, set "Progressive" in the Picture menu to "Off".	37
	● Check the settings for "TV Aspect" in the Setup menu.	61
<b>Screen size is wrong.</b>	● If you connect an HDMI cable, set "Aspect for 4:3 Video" to "16:9" in the Setup menu.	61
<b>The recorded title is stretched vertically.</b>	<ul style="list-style-type: none"> <li>● 16:9 aspect programmes are recorded in 4:3 aspect in the following cases. <ul style="list-style-type: none"> <li>– If you recorded to the HDD or a DVD-RAM and "Rec for High Speed Copy" was set to "On" in the Setup menu.</li> <li>– If you recorded or copied to a DVD-R, DVD-R DL, DVD-RW (DVD-Video format), +R, +R DL or +RW.</li> </ul> </li> <li>It may be possible to adjust the display mode on the TV. Refer to your television's operating instructions.</li> </ul>	59
<b>There is a lot of after-image when playing video.</b>	● Set "Playback NR" in the Picture menu to "Off".	37
<b>When playing DVD-Video using progressive output, one part of the picture momentarily appears to be doubled up.</b>	● Set "Progressive" in the Picture menu to "Off". This problem is caused by the editing method or material used on DVD-Video, but should be corrected if you use interlace output.	37
<b>There is no apparent change in picture quality when adjusted with the Picture menu in the on-screen menus.</b>	● The effect is less perceivable with some types of video.	—
<b>The images from this unit do not appear on the television.</b>	<ul style="list-style-type: none"> <li>● Make sure that the television is connected to the VIDEO OUT terminal, S VIDEO OUT terminal, COMPONENT VIDEO OUT terminals or HDMI AV OUT terminal on this unit.</li> </ul>	14–16
<b>Picture is distorted.</b>	<ul style="list-style-type: none"> <li>● Make sure that the television's input setting (e.g., AV 1) is correct.</li> <li>● Progressive output is set to on but the connected television is not progressive compatible. Press and hold [■] and [▶] (PLAY) on the main unit at the same time for more than 5 seconds to cancel this setting. The setting will change to interlace.</li> <li>● The unit's "TV System" setting differs from the TV system used by the disc now playing. While stopped, keep pressing [■] and [▲ OPEN/CLOSE] on the main unit for 5 or more seconds. The system switches from PAL to NTSC or vice versa.</li> <li>● When this unit is connected with an HDMI cable, use a disc that matches with this unit's TV system.</li> <li>● Picture may not be seen when more than 4 devices are connected with HDMI cables. Reduce the number of connected devices.</li> </ul>	— — 63 — —



Sound		Page
<b>No sound.</b> <b>Low volume.</b> <b>Distorted sound.</b> <b>Cannot hear the desired audio type.</b>	<ul style="list-style-type: none"> <li>• Check the connections and the “Digital Audio Output” settings. Check the input mode on the amplifier if you have connected one.</li> </ul>	14, 15, 60
	<ul style="list-style-type: none"> <li>• Press [AUDIO] to select the audio.</li> </ul>	30
	<ul style="list-style-type: none"> <li>• Turn off V.S.S. in the following cases.                             <ul style="list-style-type: none"> <li>– When using discs that do not have surround sound effects such as Karaoke discs.</li> <li>– When playing bilingual broadcast programmes.</li> </ul> </li> </ul>	37
	<ul style="list-style-type: none"> <li>• <b>DVD-A</b> The disc may have a restriction on the method of audio output. This unit cannot playback multi-channel discs that prevent down-mixing unless the unit is connected with an HDMI cable to an amplifier supporting CPPM and the HDMI standard (version 1.1 or later). Refer to the disc jacket for more information.</li> </ul>	—
	<ul style="list-style-type: none"> <li>• Audio may not be output due to how files were created. (DivX)</li> </ul>	—
	<ul style="list-style-type: none"> <li>• Audio may not be heard when more than 4 devices are connected with HDMI cables. Reduce the number of connected devices.</li> </ul>	—
	<ul style="list-style-type: none"> <li>• The sound effects will not work when the bitstream signal is output from the HDMI AV OUT terminal or the OPTICAL DIGITAL AUDIO OUT terminal.</li> </ul>	—
	<ul style="list-style-type: none"> <li>• To output audio from a device connected with an HDMI cable, set “Digital Audio Output” to “HDMI and Optical” in the Setup menu.</li> </ul>	61
	<ul style="list-style-type: none"> <li>• Depending on the connected equipment, the sound may be distorted if this unit is connected with an HDMI cable.</li> </ul>	—
	<ul style="list-style-type: none"> <li>• If recording to the HDD or a DVD-RAM when “Rec for High Speed Copy” is set to “On”, you can only record either the main or secondary audio of a bilingual broadcast. If you do not intend to copy the title to a DVD-R, DVD-R DL, DVD-RW (DVD-Video format), +R, +R DL or +RW set “Rec for High Speed Copy” in the Setup menu to “Off”.</li> </ul>	22
<b>Cannot switch audio.</b>	<ul style="list-style-type: none"> <li>• You cannot switch the audio in the following cases.                             <ul style="list-style-type: none"> <li>– When a DVD-R, DVD-R DL, DVD-RW (DVD-Video format), +R, +R DL or +RW disc is in the disc tray while DVD drive is selected.</li> <li>– When the recording mode is XP and “Audio Mode for XP Recording” is set to “LPCM”.</li> <li>– When “Rec for High Speed Copy” is set to “On”.</li> </ul> </li> </ul>	—
	<ul style="list-style-type: none"> <li>• The amplifier is connected using an optical digital cable or an HDMI cable. You cannot switch the audio if “Dolby Digital” is set to “Bitstream”. Set “Dolby Digital” to “PCM” or connect using audio cables.</li> </ul>	15, 16, 60
	<ul style="list-style-type: none"> <li>• There are discs for which audio cannot be changed because of how the disc was created.</li> </ul>	—
		60
		22

**Operation**

<b>Cannot operate the television.</b> <b>The remote control doesn't work.</b>	<ul style="list-style-type: none"> <li>• Change the manufacturer code. Some televisions cannot be operated even if you change the code.</li> </ul>	19
	<ul style="list-style-type: none"> <li>• The remote control and main unit are using different codes. Change the code on the remote control.</li> </ul>	19
	 <p>Press and hold [ENTER] and the indicated number button at the same time for more than 2 seconds.</p>	
	<ul style="list-style-type: none"> <li>• The batteries are depleted. Replace them with new ones.</li> </ul>	11
	<ul style="list-style-type: none"> <li>• You are not pointing the remote control at the main unit's remote control signal sensor during operation.</li> </ul>	—
	<ul style="list-style-type: none"> <li>• Coloured glass may obstruct the signal reception/transmission.</li> </ul>	—
	<ul style="list-style-type: none"> <li>• Don't place the signal sensor in direct sunlight or in areas that may be subject to sunlight exposure.</li> </ul>	—
	<ul style="list-style-type: none"> <li>• It may be necessary to set the code on the remote control again after changing the batteries.</li> </ul>	19
	<ul style="list-style-type: none"> <li>• It may be necessary to set the manufacturer code again after changing the batteries.</li> </ul>	19
	<ul style="list-style-type: none"> <li>• The child lock function is activated.</li> </ul>	57
<b>The unit is on but cannot be operated.</b>	<ul style="list-style-type: none"> <li>• Recording drive or playback drive has not been selected properly.</li> </ul>	20, 28
	<ul style="list-style-type: none"> <li>• Some operations may be prohibited by the disc.</li> </ul>	—
	<ul style="list-style-type: none"> <li>• The unit is hot (“U59” appears on the display). Wait for “U59” to disappear.</li> </ul>	—
	<ul style="list-style-type: none"> <li>• One of the unit's safety devices may have been activated. Reset the unit as follows:                             <ol style="list-style-type: none"> <li>1 Press [⏻/I] on the main unit to switch the unit to standby. If the unit doesn't switch to standby, press and hold [⏻/I] on the main unit for about 10 seconds. The unit is forcibly switched to standby. Alternatively, disconnect the AC mains lead, wait one minute, then reconnect it.</li> <li>2 Press [⏻/I] on the main unit to switch it on. If the unit still cannot be operated, consult the dealer.</li> </ol> </li> </ul>	—
<b>HDD activation is slow.</b>	<ul style="list-style-type: none"> <li>• The HDD is in SLEEP mode. (“SLEEP” appears in the unit's display.)</li> </ul>	9
<b>Cannot eject disc.</b>	<ul style="list-style-type: none"> <li>• The unit is recording.</li> </ul>	—
	<ul style="list-style-type: none"> <li>• The unit may have a problem. While the unit is off, press and hold [■] and [CH ^] on the main unit at the same time for about 5 seconds. Remove the disc and consult the dealer. If the Child Lock function is activated, above operation does not work. Cancel the Child Lock function.</li> </ul>	57
<b>Cannot tune channels.</b>	<ul style="list-style-type: none"> <li>• Check the connections.</li> </ul>	14
<b>Startup is slow.</b>	<ul style="list-style-type: none"> <li>• Make sure that “Quick Start” is set to “On”.</li> </ul>	61
	<ul style="list-style-type: none"> <li>• Startup takes time in the following situations:                             <ul style="list-style-type: none"> <li>– A disc other than a DVD-RAM is inserted.</li> <li>– The clock is not set.</li> <li>– Immediately after a power failure or the AC mains lead is connected.</li> <li>– For a few minutes after 5:15 am due to system maintenance of this unit.</li> <li>– When the unit is connected with an HDMI cable.</li> </ul> </li> </ul>	—
		—
		—
		—
<b>Takes time to read DVD-RAM.</b>	<ul style="list-style-type: none"> <li>• It may take time to read a disc if it is being used for the first time in this unit or it has not been used for a long time.</li> </ul>	—

Recording, timer recording and copying		Page
<b>Cannot record. Cannot copy.</b>	<ul style="list-style-type: none"> <li>You haven't inserted a disc or the disc you inserted cannot be recorded on. Insert a disc the unit can record onto.</li> </ul>	4, 5
	<ul style="list-style-type: none"> <li>The disc is unformatted. Format the disc. <b>RAM -RW(V) +R +R DL +RW</b></li> </ul>	54
	<ul style="list-style-type: none"> <li>The write-protect tab on the cartridge is set to PROTECT, or the disc is protected with DVD Management.</li> </ul>	53
	<ul style="list-style-type: none"> <li>Some programmes have limitations on the number of times they can be recorded (CPRM).</li> </ul>	73
	<ul style="list-style-type: none"> <li>You cannot record when there is not enough space or when the number of titles has reached its limit. Delete unwanted titles or use a new disc.</li> </ul>	39, 44, 54
	<ul style="list-style-type: none"> <li>You cannot directly record to a DVD-R DL or +R DL disc on this unit.</li> </ul>	—
	<ul style="list-style-type: none"> <li>Record to the HDD and then copy to the disc.</li> </ul>	—
	<ul style="list-style-type: none"> <li><b>-R DL +R DL</b> In the following situations, you cannot copy. Delete unnecessary titles from the HDD and then copy.                             <ul style="list-style-type: none"> <li>-If there is not enough space available on the HDD (If you will copy titles from the HDD to a blank disc and fill the entire disc, HDD disc space equivalent to 4 hours of SP mode recording is necessary).</li> <li>-If the number of recorded titles and the number of titles to be copied has exceeded 500.</li> </ul> </li> </ul>	39, 44, 54
	<ul style="list-style-type: none"> <li>You cannot record and copy on finalized discs. However, you can record and copy again if you format DVD-RW.</li> </ul>	—
	<ul style="list-style-type: none"> <li>Due to peculiarities of DVD-R, DVD-R DL, DVD-RW (DVD-Video format), +R, +R DL and +RW you may be unable to record onto them if you either insert and remove the disc or switch the unit on and off while a disc is loaded, a total of fifty times.</li> </ul>	—
<ul style="list-style-type: none"> <li>DVD-R, DVD-R DL, DVD-RW (DVD-Video format), +R, +R DL and +RW recorded on this unit may not be recordable on other Panasonic DVD Recorders.</li> </ul>	—	
<ul style="list-style-type: none"> <li>This unit cannot record to discs containing both PAL and NTSC signals. (However, both types of programmes can be recorded onto the HDD.) Play of discs recorded with both PAL and NTSC on another unit is not guaranteed.</li> </ul>	—	
<b>Cannot record from external equipment.</b>	<ul style="list-style-type: none"> <li>Check that the connection is correct.</li> <li>Select the input channel for the equipment you have connected.</li> </ul>	14, 52 —
<b>Timer recording does not work properly.</b>	<ul style="list-style-type: none"> <li>The timer programme is incorrect or different timer programme times overlap. Correct the programme.</li> <li>The programme is not in timer recording standby. (The timer icon "⊙" in the timer recording list is not on.)                             <ol style="list-style-type: none"> <li>Press [PROG/CHECK].</li> <li>Press [▲, ▼] to select the programme and press [A].</li> </ol> </li> </ul>	27 27
<b>G-CODE* programming does not work properly.</b> * Only for Australia and N.Z.	<ul style="list-style-type: none"> <li>Set the clock.</li> </ul>	64
<b>Timer recording does not stop even when [■] is pressed.</b>	<ul style="list-style-type: none"> <li>Make sure that the recording drive is selected. Press [DRIVE SELECT] to select the recording drive.</li> <li>If you start recording immediately after turning on the unit while "Quick Start" is set to "On", you cannot then stop recording for a few seconds.</li> </ul>	26 —
<b>The timer programme remains even after recording finishes.</b>	<ul style="list-style-type: none"> <li>The timer programme remains if set to daily or weekly.</li> </ul>	25
<b>A part or whole of a recorded title has been lost.</b>	<ul style="list-style-type: none"> <li>If there is a power failure or the plug is disconnected from the household mains socket while recording or editing, the title may be lost or the HDD/disc may become unusable. You will have to format the disc (<b>HDD RAM -RW(V) +RW</b>) or use a new disc. We cannot offer any guarantee regarding lost programmes or discs.</li> </ul>	— 54
<b>Cannot copy to a DVD-R, etc. disc using the high speed mode.</b>	<ul style="list-style-type: none"> <li>When recording to the HDD, set "Rec for High Speed Copy" to "On" in the Setup menu.</li> <li><b>+R +R DL +RW</b> If recorded in EP or FR (recordings 5 hours or longer) mode, you cannot perform high-speed copy.</li> <li><b>+R +R DL +RW</b> Titles recorded on other Panasonic DVD recorders with "Rec for High Speed Copy" set to "On", and then copied to the HDD on this unit may not copy to +R, +R DL or +RW discs with high-speed copy.</li> </ul>	22 — —
<b>When copying, it takes a long time even when high speed mode is selected.</b>	<ul style="list-style-type: none"> <li>Use a disc that is compatible with high speed recording. Even if the disc is high speed recording compatible, the maximum speed may not be possible due to the condition of the disc.</li> <li>It takes longer than normal to copy many titles.</li> <li>You cannot high speed copy to DVD-R titles longer than 6 hours when using other Panasonic DVD Recorders that are not compatible with EP (8 Hours) mode recording.</li> </ul>	— — —
<b>An unusually loud sound is coming from the rotating DVD-R, etc.</b>	<ul style="list-style-type: none"> <li>When recording or high speed copying to a DVD-R, DVD-R DL, DVD-RW (DVD-Video format), +R, +R DL and +RW the sound of the disc rotating may be louder than normal, however, this is not a problem.</li> </ul>	—
<b>The DV automatic recording function does not work.</b>	<ul style="list-style-type: none"> <li>If images cannot be recorded or if the recording is aborted, check the connections and DV equipment settings.</li> <li>You cannot start recording until the images from the DV equipment appear on the television.</li> <li>Recording may not be performed as desired if the time codes on the tape in the DV equipment are not successive.</li> <li>Depending on the equipment, the DV automatic recording may not operate properly.</li> <li>The audio/video recordings are recorded on other than a DV tape.</li> </ul>	52 — — — 52

Play		Page
Play fails to start even when [▶] (PLAY) is pressed. Play starts but then stops immediately.	● Insert the disc correctly with the label facing up.	28
	● The disc is dirty.	10
	● You tried to play a blank disc or disc unplayable on this unit.	4-6
	● You tried to play a +RW that needs to be finalized on the equipment used for recording.	—
	● You may be able to copy a "One time only recording" title that was recorded to DVD-RAM using a different Panasonic DVD Recorder to this unit's HDD, but play is not possible due to copyright protection.	—
Audio and video momentarily pause.	● When recording to DVD-RAM using "EP (8 Hours)" mode, play may not be possible on DVD players that are compatible with DVD-RAM. In this case use "EP (6 Hours)" mode.	59
	● You cannot play discs during DV automatic recording.	—
	● If playing DivX VOD content, refer to the homepage where you purchased it. (DivX)	33
	● This occurs between playlist chapters.	—
DVD-Video is not played.	● This occurs between chapters and with partially deleted titles on finalized DVD-R, DVD-R DL, DVD-RW (DVD-Video format), +R, +R DL and +RW that have been copied using the high speed mode.	—
	● This occurs as scenes change during Quick View.	—
Alternative soundtrack and subtitles cannot be selected.	● -R DL +R DL When playing a title recorded on both layers, the unit automatically switches between layers and plays the title in the same way as a normal programme. However, video and audio may momentarily cut out when the unit is switching layers.	5
No subtitles.	● Subtitles are not recorded on the disc.	—
Angle cannot be changed.	● Turn the subtitles on. Set "Subtitle" on the on-screen menu to "On".	36
You have forgotten your ratings password. You want to cancel the ratings level.	● Angles can only be changed during scenes where different angles are recorded.	—
Quick View does not work.	● The ratings level returns to the factory preset. While the disc tray is open, press [DRIVE SELECT] to select the DVD drive, then press and hold [● REC] and [▶] (PLAY) on the main unit at the same time for 5 or more seconds ("INIT" will appear on the unit's display).	—
The resume play function does not work.	● This does not work when audio is other than Dolby Digital.	—
The Video CD picture does not display properly.	● This does not work when recording is in XP or FR mode.	—
	● Memorized positions are cancelled when -press [■] several times. -open the disc tray (excluding HDD). -DVD-A   CD   VCD   SD turn off the power. -if a recording or timer recording was executed.	—
Time Slip does not work.	● When connecting to Multi-system TV, select "NTSC" in "TV System" in the Setup menu.	63
It takes time before play starts.	● When connecting to PAL TV, the lower part of the picture cannot be displayed correctly during search.	—
	● Time Slip does not work when the unit's "TV System" settings are different from the title recorded on the disc.	63
Picture stops.	● This is normal on DivX video. (DivX)	—
	● Picture may stop if the DivX files are greater than 2 GB. (DivX)	—

Edit		Page
Available disc space does not increase even after deleting a title.	● Available disc space does not increase after deleting on DVD-R, DVD-R DL, +R or +R DL.	44
	● Disc space increases only when the last recorded title is deleted on DVD-RW (DVD-Video format) and +RW. The disc space does not increase when any other titles are deleted.	—
Cannot edit.	● You may not be able to edit on the HDD if there is no available space. Delete any unwanted titles to create empty space.	44
Cannot format.	● The disc is dirty. Wipe with a damp cloth and then wipe dry.	10
	● You tried formatting a disc that you may not be able to use in this unit.	4-6
Cannot create chapters.	● The unit writes the chapter division information to the disc when you turn it off or remove the disc. The information is not written if there is an interruption to the power before this.	—
Cannot mark the start point or the end point during "Partial Delete" operation.	● These operations are not possible with still pictures.	—
	● You cannot set points if they are too close to each other. You cannot set an end point before a start point.	—
Cannot delete chapters.	● When the chapter is too short to delete, use "Combine Chapters" to make the chapter longer.	39
Cannot create a playlist.	● You cannot select all the chapters at once in a title if the title also includes still pictures. Select them individually.	—

## Still pictures

<b>Cannot display Direct Navigator screen.</b>	<ul style="list-style-type: none"> <li>This screen cannot be displayed during recording or copy.</li> </ul>	—
<b>Cannot edit or format a card.</b>	<ul style="list-style-type: none"> <li>Release the card's protection setting. (With some cards, the "Write Protection Off" message sometimes appears on the screen even when protection has been set.)</li> </ul>	53
<b>The contents of the card cannot be read.</b>	<ul style="list-style-type: none"> <li>The card format is not compatible with the unit. (The contents on the card may be damaged.) Format using FAT 12 or FAT 16 with other equipment or format the card with this unit.</li> <li>The card contains a folder structure and/or file extensions that are not compatible with this unit.</li> <li>Turn off and then turn on the unit again.</li> <li>You can use SD Memory Cards with capacities from 8 MB to 2 GB.</li> </ul>	7, 31 54 7
<b>Copying, deleting and setting protection takes a long time.</b>	<ul style="list-style-type: none"> <li>When there are a lot of folders and files, it may sometimes take a few hours.</li> <li>When repeating copying or deleting, it may sometimes take a long time. Format the disc or card.</li> </ul>	— 54

## To reset this unit

<b>To return all the settings other than the main ones to the factory preset</b>	<ul style="list-style-type: none"> <li>Select "Yes" in "Shipping Condition" in the Setup menu. All the settings except for the ratings level, ratings password and time settings return to the factory preset. The timer recording programmes are also cancelled.</li> <li>Select "Yes" in "Default Settings" in the Setup menu. All the settings other than the programmed channels, time settings, country settings*, disc language settings, ratings level, ratings password, remote control code, return to the factory presets.</li> <li>Press and hold [v CH] and [CH ^] on the main unit until the Country setting screen* or the Auto-Setup screen appears. All the settings except for the ratings level, ratings password and time settings return to the factory preset. The timer recording programmes are also cancelled.</li> </ul> <p>* Only for Australia and N.Z.</p>	61 61 —
<b>To reset the ratings level settings</b>	<ul style="list-style-type: none"> <li>While the disc tray is open, press [DRIVE SELECT] to select the DVD drive, then press and hold [● REC] and [▶] (PLAY) on the main unit at the same time for 5 or more seconds.</li> </ul>	—
<b>To restore the unit if it freezes due to one of the safety devices being activated</b>	<ul style="list-style-type: none"> <li>Press and hold [⏻/I] on the main unit for 10 seconds. (The settings remain.)</li> </ul>	—

## Bitstream

This is the digital form of multi-channel audio data (e.g., 5.1 channel) before it is decoded into its various channels.

## CPPM (Content Protection for Pre-recorded Media)

A copy protection system used for DVD-Audio files. This unit supports CPPM.

## CPRM (Content Protection for Recordable Media)

CPRM is technology used to protect broadcasts that are allowed to be recorded only once. Such broadcasts can be recorded only with CPRM compatible recorders and discs.

## Decoder

A decoder restores the coded audio signals on DVDs to normal. This is called decoding.

## DivX

A video compression format developed by DivXNetworks, Inc. that compresses video files without any considerable loss of video quality.

## Dolby Digital

This is a method of coding digital signals developed by Dolby Laboratories. Apart from stereo (2-channel) audio, these signals can also be multi-channel audio. A large amount of audio information can be recorded on one disc using this method.

When recording on this unit Dolby Digital (2 channel) is the default audio.

## Down-mixing

This is the process of remixing the multi-channel audio found on some discs into two channels. It is useful when you want to listen to the 5.1-channel audio recorded on DVDs through your television's speakers. Some discs prohibit down-mixing and this unit can then only output the front two channels.

**DVD-A** Tracks that do not allow down-mixing will not play correctly on this unit except when connecting with an HDMI cable to an amplifier that meets HDMI standards (Ver. 1.1 or later) and is CPPM compatible.

## DPOF (Digital Print Order Format)

DPOF is the standard printing format for still picture data taken by a digital camera, etc. It is used for automatic printing at a photo developing store or on your home printer.

## Drive

In the instance of this unit, this refers to the hard disk (HDD), disc (DVD) and SD card (SD). These perform the reading and writing of data.

## DTS (Digital Theater Systems)

This surround system is used in many movie theaters. There is good separation between the channels, so realistic sound effects are possible.

## Dynamic range

Dynamic range is the difference between the lowest level of sound that can be heard above the noise of the equipment and the highest level of sound before distortion occurs.

Dynamic range compression means reducing the gap between the loudest and softest sounds. This means you can listen at low volumes but still hear dialogue clearly.

## Film and video

DVD-Videos are recorded using either film or video. This unit can determine which type has been used, then uses the most suitable method of progressive output.

Film: Recorded at 25 frames per second (PAL discs) or 24 frames per second (NTSC discs). (NTSC discs recorded at 30 frames per second as well.)

Generally appropriate for motion picture films.

Video: Recorded at 25 frames/50 fields per second. (PAL discs) or 30 frames/60 fields per second (NTSC discs). Generally appropriate for TV drama programmes or animation.

## Finalize

A process that makes play of a recorded CD-R, CD-RW, DVD-R, etc. possible on equipment that can play such media. You can finalize DVD-R, DVD-R DL, DVD-RW (DVD-Video format), +R, +R DL on this unit. After finalizing, the disc becomes play-only and you can no longer record or edit. However, finalized DVD-RW can be formatted to become recordable.

## Folder

This is a place on the hard disk or memory card where groups of data are stored together. In the case of this unit, it refers to the place where still pictures (JPEG, TIFF) and MPEG2 are stored.

## Formatting

Formatting is the process of making media such as DVD-RAM recordable on recording equipment.

You can format DVD-RAM, DVD-RW (only as DVD-Video format), +RW, SD Memory Cards and the HDD or unused +R and +R DL on this unit. Formatting deletes irrevocably all contents.

## Frames and fields

Frames refer to the single images that constitute the video you see on your television. Each frame consists of two fields.

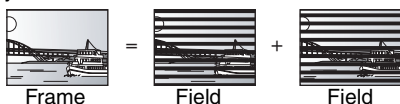

- A frame still shows two fields, so there may be some blurring, but picture quality is generally better.
- A field still shows less picture information so it may be rougher, but there is no blurring.

## HDD (Hard disk drive)

This is a mass data storage device used in computers, etc. A disk with a surface that has been treated with magnetic fluid is spun and a magnetic head is brought in close proximity to facilitate the reading and writing of large amounts of data at high speed.

## HDMI (High Definition Multimedia Interface)

HDMI is a next-generation digital interface for consumer electronic products. Unlike conventional connections, it transmits uncompressed digital video and audio signals on a single cable. This unit supports high-definition video output [720p (750p), 1080i (1125i)] from HDMI AV OUT terminals. To enjoy high-definition video a high definition compatible television is required.

## JPEG (Joint Photographic Experts Group)

This is a system used for compressing/decoding colour still pictures. If you select JPEG as the storage system on digital cameras, etc., the data will be compressed to 1/10–1/100 of its original size. The benefit of JPEG is less deterioration in picture quality considering the degree of compression.

## LPCM (Linear PCM)

These are uncompressed digital signals, similar to those found on CDs. LPCM sound is available when recording in XP mode.

## MPEG2 (Moving Picture Experts Group)

A standard for efficiently compressing and expanding colour video. MPEG2 is a compression standard used for DVD and satellite based digital broadcasting. This unit records programmes using MPEG2. MPEG2 moving picture files shot with a Panasonic SD multi-camera, etc. can be copied to the HDD or a DVD-RAM disc.

## MP3 (MPEG Audio Layer 3)

An audio compression method that compresses audio to approximately one tenth of its size without any considerable loss of audio quality. You can play MP3 you have recorded onto CD-R and CD-RW.

## Pan&Scan/Letterbox

In general, DVD-Video are produced with the intention that they be viewed on a widescreen television (16:9 aspect ratio), so images often don't fit regular (4:3 aspect ratio) televisions. Two styles of picture, "Pan & Scan" and "Letterbox", deal with this problem.

Pan & Scan: The sides are cut off so the picture fills the screen.



Letterbox: Black bands appear at the top and bottom of the picture so the picture itself appears in an aspect ratio of 16:9.



## Playback control (PBC)

If a Video CD has playback control, you can select scenes and information with menus.

(This unit is compatible with version 2.0 and 1.1.)

## Progressive/Interlace

The PAL video signal standard has 625 (or 576) interlaced (i) scan lines, whereas progressive scanning, called 625p (or 576p), uses twice the number of scan lines. For the NTSC standard, these are called 525i (or 480i) and 525p (or 480p) respectively. Using progressive output, you can enjoy the high-resolution video recorded on media such as DVD-Video.

Your television must be compatible to enjoy progressive video.

Panasonic televisions with 625 (576)/50i · 50p, 525 (480)/60i · 60p input terminals are progressive compatible.

## Protection

You can prevent accidental deletion by setting writing protection or deletion protection.

## RGB

This refers to the three primary colours of light, red (R), green (G), and blue (B) and also the method of producing video that uses them. By dividing the video signal into the three colours for transmission, noise is reduced for even higher quality images.

## Sampling frequency

Sampling is the process of converting the heights of sound wave (analog signal) samples taken at set periods into digits (digital encoding).

Sampling frequency is the number of samples taken per second, so larger numbers mean more faithful reproduction of the original sound.

## Thumbnail

This refers to a miniature representation of a picture used to display multiple pictures in the form of a list.

## TIFF (Tag Image File Format)

This is a system used for compressing/decoding colour still pictures, a common format for storing high quality images on digital cameras and other devices.

## 1080i

In one high definition image, 1080 (1125) alternating scan lines pass every 1/60<sup>th</sup> of a second to create an interlace image. Because 1080i (1125i) more than doubles current television broadcasts of 480i (525i), the detail is much clearer and creates a more realistic and rich image.

## 720p

In one high definition image, 720 (750) scan lines pass at the same time every 1/60<sup>th</sup> of a second to create a progressive image. Since progressive video does not alternate scan lines like interlace, there is a minimal amount of screen flicker.

# Specifications

**Recording system** DVD-RAM : DVD Video Recording format  
 DVD-R : DVD-Video format  
 DVD-R DL (Dual Layer) : DVD-Video format  
 DVD-RW : DVD-Video format  
 +R  
 +R DL (Double Layer)  
 +RW

**Recordable discs**  
 DVD-RAM: Ver. 2.0  
 Ver. 2.1/3X-SPEED DVD-RAM Revision 1.0  
 Ver.2.2/5X-SPEED DVD-RAM Revision 2.0  
 DVD-R: for General Ver. 2.0/4X-SPEED DVD-R Revision 1.0  
 for General Ver.2.x/8X-SPEED DVD-R Revision 3.0  
 for General Ver.2.x/16X-SPEED DVD-R Revision 6.0  
 for DL Ver.3.0  
 for DL Ver.3.x/4X-SPEED DVD-R for DL Revision 1.0  
 DVD-RW: Ver. 1.1  
 Ver. 1.x/2X-SPEED DVD-RW Revision 1.0  
 Ver. 1.x/4X-SPEED DVD-RW Revision 2.0  
 Ver. 1.x/6X-SPEED DVD-RW Revision 3.0  
 +R: Ver. 1.0  
 Ver. 1.1  
 Ver. 1.2  
 Ver. 1.3  
 for DL Ver.1.0  
 +RW: Ver. 1.1  
 Ver.1.2/4X-SPEED

**Recording time** Maximum 8 hours (using 4.7 GB disc)  
 XP: Approx. 1 hour, SP: Approx. 2 hours  
 LP: Approx. 4 hours, EP: Approx. 6 hours/8 hours  
 Maximum Approx. 443 hours with 250 GB HDD (EP 8 hours mode)  
 XP: Approx. 55 hours, SP: Approx. 111 hours  
 LP: Approx. 222 hours, EP: Approx. 333 hours/443 hours

**Playable discs**  
 DVD-RAM : DVD Video Recording format  
 DVD-R : DVD-Video format, DivX  
 DVD-R DL (Dual Layer) : DVD-Video format  
 DVD-RW : DVD-Video format, DVD Video Recording format  
 +R, +R DL (Double Layer), +RW  
 DVD-Video, DVD-Audio, CD-Audio (CD-DA), Video CD,  
 CD-R/CD-RW (CD-DA, Video CD, MP3, JPEG, DivX formatted discs)

**Internal HDD capacity** 250 GB

**Optical pick-up** System with 1 lens, 2 integration units  
 (662 nm wavelength for DVDs, 780 nm wavelength for CDs)

**LASER specification**  
 Class 1 LASER Product (Pickup)  
 Wave length: (CD) 780 nm wave length, (DVD) 662 nm wave length  
 Laser power:  
 No hazardous radiation is emitted with the safety protection

**Audio**  
 Recording system: Dolby Digital 2ch, Linear PCM (XP mode)  
 Audio in: AV1/AV2 (21 pin), AV3/AV4 (pin jack)  
 Input level: Standard: 0.5 Vrms, Full scale: 2.0 Vrms at 1 kHz  
 Input impedance: More than 10 kΩ  
 Audio out: AV1/AV2 (21 pin), Audio Out (pin jack)  
 Output level: Standard: 0.5 Vrms, Full scale: 2.0 Vrms at 1 kHz  
 Output impedance: Less than 1 kΩ  
 Digital audio out: Optical terminal (PCM, Dolby Digital, DTS, MPEG)

**Video**  
 Video system:  
**For Asia and Middle East**  
 SECAM (only input)/PAL colour signal, 625 lines, 50 fields  
 NTSC colour signal, 525 lines, 60 fields  
**For Australia and N.Z.**  
 PAL colour signal, 625 lines, 50 fields  
 NTSC colour signal, 525 lines, 60 fields

Recording system: MPEG2 (Hybrid VBR)

**For Asia and Middle East** Video in (SECAM/PAL/NTSC):  
 AV1/AV2 (21 pin), AV3/AV4 (pin jack) 1 Vp-p 75 Ω, termination

**For Australia and N.Z.** Video in (PAL/NTSC):  
 AV1/AV2 (21 pin), AV3/AV4 (pin jack) 1 Vp-p 75 Ω, termination

**For Asia and Middle East** S-Video in (SECAM/PAL/NTSC):  
 AV2 (21 pin), AV3/AV4 (S terminal) 1 Vp-p 75 Ω, termination

**For Australia and N.Z.** S-Video in (PAL/NTSC):  
 AV2 (21 pin), AV3/AV4 (S terminal) 1 Vp-p 75 Ω, termination

Video out (PAL/NTSC):  
 AV1/AV2 (21 pin), Video Out (pin jack) 1 Vp-p 75 Ω, termination  
 S-Video out (PAL/NTSC):  
 AV1 (21 pin), S-Video Out (S terminal) 1 Vp-p 75 Ω, termination  
 RGB out (PAL/NTSC):  
 AV1 (21 pin) 0.7 Vp-p (PAL) 75 Ω, termination  
 Component video output (NTSC 480p/480i, PAL 576p/576i)  
 Y: 1.0 Vp-p 75 Ω, termination  
 Pb: 0.7 Vp-p 75 Ω, termination  
 Pr: 0.7 Vp-p 75 Ω, termination

## Television system

### For Asia

Tuner system	Channel coverage
PAL-DK, SECAM-DKK1 OIRT	VHF: R1 to R12 UHF: 21 to 69 CATV: 44 MHz to 470 MHz
PAL-BGH, SECAM-BG CCIR	VHF: E2 to E12 UHF: E21 to E69 CATV: S01 to S05, M1 to M10, U1 to U10, S21 to S41
PAL-I Hong Kong	UHF: 21 to 69
PAL-D China	VHF: 1 to 12 UHF: 13 to 57 CATV: Z1 to Z35

RF converter output: Not provided

### For Australia and N.Z.

Tuner system	Channel coverage
PAL-B Australia	VHF: 0 to 12 UHF: 28 to 69 CATV: 45 MHz to 470 MHz
PAL-BG New Zealand	VHF: 1 to 11 UHF: 21 to 69 CATV: 44 MHz to 470 MHz

RF converter output: Not provided

### For Middle East

Tuner system	Channel coverage
PAL-BGH, SECAM-BG CCIR	VHF: E2 to E12 UHF: E21 to E69 CATV: S01 to S05, M1 to M10, U1 to U10, S21 to S41

RF converter output: Not provided

## SD card slot

SD Memory Card slot: 1 pc

Still picture (JPEG, TIFF)

Compatible media: SD Memory Card\*, MultiMediaCard  
 Format: FAT12, FAT16

Image file format:  
 JPEG conforming DCF (Design rule for Camera File system),  
 (sub sampling; 4:2:2 or 4:2:0)  
 TIFF (Uncompressed RGB chunky), DPOF Compatible  
 Number of pixels: 34 × 34 to 6144 × 4096  
 Thawing time: Approx. 3 sec (6 M pixels, JPEG)

## SD Video (MPEG2)

Compatible media: SD Memory Card\*, MultiMediaCard  
 Codec: MPEG 2 (SD-Video Entertainment Video Profile)  
 File Format: SD-Video format conforming  
 Video Recording conversion and transfer is possible from card  
 to HDD or DVD-RAM disc.  
 After Video Recording conversion and transfer to HDD or DVD-  
 RAM disc, the playback is possible.

**DV input** IEEE 1394 Standard, 4 pin : 1 pc

**HDMI Output** 19 pin type A: 1 pc

**HDMI** HDMI Ver.1.2a (EDID Ver.1.3)

## Others

Region code:

**For Asia** #3

**For Australia and N.Z.** #4

**For Middle East** #2

Operating temperature: 5 °C to 40 °C

Operating humidity range: 10 % to 80 % RH (no condensation)

Power supply:

**For Asia and Middle East** AC 220 to 240 V, 50/60 Hz

**For Australia and N.Z.** AC 220 to 240 V, 50 Hz

Power consumption: Approx. 34 W

Dimensions (W×D×H): Approx. 430 mm×329 mm×58 mm

Mass: Approx. 4.2 kg

**Power consumption in standby mode:**  
**Approx. 2 W (Power Save mode)**

## Note

Specifications are subject to change without notice.  
 Mass and dimensions are approximate.

\* Includes miniSD™ cards. (A miniSD™ adaptor needs to be inserted.)

• Useable capacity will be less (SD Memory Card).



# Safety precautions

## Placement

Set the unit up on an even surface away from direct sunlight, high temperatures, high humidity, and excessive vibration. These conditions can damage the cabinet and other components, thereby shortening the unit's service life.

Do not place heavy items on the unit.

## Voltage

Do not use high voltage power sources. This can overload the unit and cause a fire.

Do not use a DC power source. Check the source carefully when setting the unit up on a ship or other place where DC is used.

## AC mains lead protection

Ensure the AC mains lead is connected correctly and not damaged. Poor connection and lead damage can cause fire or electric shock. Do not pull, bend, or place heavy items on the lead.

Grasp the plug firmly when unplugging the lead. Pulling the AC mains lead can cause electric shock.

Do not handle the plug with wet hands. This can cause electric shock.

## Foreign matter

Do not let metal objects fall inside the unit. This can cause electric shock or malfunction.

Do not let liquids get into the unit. This can cause electric shock or malfunction. If this occurs, immediately disconnect the unit from the power supply and contact your dealer.

Do not spray insecticides onto or into the unit. They contain flammable gases which can ignite if sprayed into the unit.

## Service

Do not attempt to repair this unit by yourself. If sound is interrupted, indicators fail to light, smoke appears, or any other problem that is not covered in these instructions occurs, disconnect the AC mains lead and contact your dealer or an authorized service centre. Electric shock or damage to the unit can occur if the unit is repaired, disassembled or reconstructed by unqualified persons.

Extend operating life by disconnecting the unit from the power source if it is not to be used for a long time.

Manufactured under license from Dolby Laboratories. "Dolby" and the double-D symbol are trademarks of Dolby Laboratories.

"DTS" and "DTS 2.0+ Digital Out" are trademarks of Digital Theater Systems, Inc.

This product incorporates copyright protection technology that is protected by U.S. patents and other intellectual property rights. Use of this copyright protection technology must be authorized by Macrovision, and is intended for home and other limited consumer uses only unless otherwise authorized by Macrovision. Reverse engineering or disassembly is prohibited.

- SD logo is a trademark.
- Portions of this product are protected under copyright law and are provided under license by ARIS/SOLANA/4C.
- miniSD™ is a trademark of SD Card Association.

Official DivX Certified™ product. Plays DivX®5, DivX®4, DivX®3, and DivX® VOD video content (in compliance with DivX Certified™ technical requirements).

DivX, DivX Certified, and associated logos are trademarks of DivXNetworks, Inc. and are used under license.

HDMI, the HDMI logo and High-Definition Multimedia Interface are trademarks or registered trademarks of HDMI Licensing LLC.

HDAVI Control™ is a trademark of Matsushita Electric Industrial Co., Ltd.

<b>Album</b>		<b>Quick Start</b> .....	20
Edit .....	42	<b>Quick View</b> .....	29
Play .....	34	<b>Ratings level</b> .....	59
<b>Angle</b> .....	36	<b>Rec for High Speed Copy</b> .....	22, 59
<b>Aspect</b> .....	17	<b>Recording</b> .....	20
<b>Audio</b>		Auto Renewal .....	27
Attribute .....	36	DV automatic recording .....	52
Language .....	36	Flexible Recording .....	23
Playback .....	30	Mode .....	21
Receiving .....	37	Relief .....	27
<b>Auto Renewal Recording</b> .....	27	Timer .....	24–27
<b>AV2</b> .....	61	<b>Relief Recording</b> .....	27
<b>AV-in NR</b> .....	37	<b>Remote control code</b> .....	19
<b>Change Thumbnail</b> .....	39	<b>Repeat Play</b> .....	37
<b>Channel</b>		<b>Resume play function</b> .....	29
Audio .....	36	<b>RGB</b> .....	61, 73
Settings .....	62	<b>SD card</b> .....	7, 13
<b>Chapter</b> .....	30, 38	<b>Setup menu</b> .....	58
<b>Chasing playback</b> .....	23	<b>Shipping Condition</b> .....	61
<b>Child Lock</b> .....	57	<b>Simultaneous rec and play</b> .....	23
<b>Cleaning</b>		<b>Soundtrack</b> .....	36
Disc .....	10	<b>Status messages</b> .....	37
Lens .....	10	<b>Still picture</b>	
Main unit .....	10	Copy .....	50
<b>Clock settings</b> .....	64	Edit .....	42
<b>Connection</b>		Play .....	34
Aerial .....	14	<b>Subtitle</b> .....	36
Amplifier, system component .....	15	<b>TIFF</b> .....	31, 73
DV input terminal .....	52	<b>Time Slip</b> .....	30
HDMI .....	16	<b>Timer recording</b> .....	24–27
Television .....	14–16	<b>Transfer</b> .....	37
Video cassette recorder .....	14	<b>Tuning</b>	
<b>Copy</b>		Automatic .....	17, 63
SD card (MPEG2) .....	49	Manual .....	62
Still picture .....	50	<b>TV System (PAL/NTSC)</b> .....	63
Title/Playlist .....	45	<b>V.S.S.</b> .....	37
<b>Copy (playlist)</b> .....	41		
<b>Country setting</b> .....	17		
<b>CPPM</b> .....	73		
<b>CPRM</b> .....	73		
<b>Create Chapter</b> .....	30, 39		
<b>Create playlists</b> .....	40		
<b>Default Settings</b> .....	61		
<b>Delete</b>			
Album .....	43		
All titles .....	54		
Chapter .....	39, 41		
Playlist .....	41		
Still picture .....	43		
Title .....	39		
<b>DELETE Navigator</b> .....	44		
<b>Dialog Enhancer</b> .....	37		
<b>Direct Navigator</b> .....	28, 34, 38, 42		
<b>Discs</b> .....	4–6		
<b>Divide Title</b> .....	39		
<b>DivX</b> .....	31–33, 73		
<b>DPOF</b> .....	43, 73		
<b>DV automatic recording</b> .....	52		
		<b>Enabling discs to be played on other equipment– Finalize</b> .....	55
		<b>Finalize</b> .....	5, 55, 73
		<b>Flexible Recording</b> .....	23
		<b>Format</b> .....	5, 54, 73
		<b>FR (Flexible Recording Mode)</b> .....	21
		<b>FUNCTIONS window</b> .....	57
		<b>G-CODE</b> .....	24
		<b>HDAVI Control</b> .....	16
		<b>HDMI</b> .....	16, 61, 73
		<b>Important notes for recording</b> .....	8
		<b>JPEG</b> .....	31, 73
		<b>Language</b>	
		Audio .....	59
		Code list .....	64
		Soundtrack .....	36, 59
		Subtitle .....	36, 59
		<b>LPCM</b> .....	60, 73
		<b>Manual Skip</b> .....	30
		<b>Menu</b>	
		DivX .....	31–33
		MP3 .....	33
		On-screen .....	36
		Setup .....	58
		<b>Mode</b>	
		Recording .....	21
		Still Mode .....	59
		<b>MP3</b> .....	31, 33
		<b>Name</b>	
		Album .....	43
		Disc .....	53
		Entering text .....	56
		Playlist .....	41
		Title .....	25, 39
		<b>Noise reduction (NR)</b>	
		AV-in NR .....	37
		Playback NR .....	37
		<b>On-screen</b>	
		Menus .....	36
		Status messages .....	37
		<b>Partial Delete</b> .....	39
		<b>PCM Down Conversion</b> .....	60
		<b>Picture settings</b> .....	37, 59
		<b>Playback NR</b> .....	37
		<b>Playlist</b> .....	40
		<b>Power Save</b> .....	61
		<b>Progressive</b> .....	18, 37, 73
		<b>Properties</b>	
		Playlist .....	41
		Still picture .....	35
		Title .....	39
		<b>Protection</b>	
		Album .....	43
		Card .....	53
		Cartridge .....	53
		Disc .....	53
		Still picture .....	43
		Title .....	39